

بِسْمِ اللّٰهِ الرَّحْمٰنِ الرَّحِیْمِ

اَللّٰهُمَّ صَلِّ عَلٰى مُحَمَّدٍ وَّ اٰلِ مُحَمَّدٍ وَّ عَجِّلْ فَرَجَهُمْ



English for Schools **PROSPECT**

1

Junior Secondary Prevocational Program



پروفیسر
ایوب علی

به نام خدا

یکی از اهداف کلیدی سند تحول بنیادین آموزش و پرورش، پرورش تربیت‌یافتگانی است که از دانش‌های پایه و عمومی سازگار با نظام معیار اسلامی برخوردار گردند و با روحیه مسئولیت‌پذیری و تعالی‌خواهی و برخوردار از مهارت‌های ارتباطی، در حیات خانوادگی و اجتماعی با رعایت اصول برگرفته از نظام معیار اسلامی، مشارکت مؤثر داشته باشند. زمینه تحقق چنین هدفی را راهکارهای مبتنی بر نظریه و پژوهش‌بنیان، نظیر طراحی، تدوین و بازتولید برنامه‌های درسی موجود با تأکید بر متناسب‌سازی حجم و محتوای کتب درسی و ساعات و روزهای آموزشی با توانمندی‌ها و ویژگی‌های دانش‌آموزان فراهم می‌کند.

بر این اساس سازمان آموزش و پرورش استثنایی کشور در مسیر اجرای سند تحول بنیادین آموزش و پرورش و به پشتوانه اهداف مندرج در اساسنامه خود، اقدام به تدوین محتوای کتب نوآموزان و دانش‌آموزان با نیازهای ویژه، مبتنی بر برنامه درسی ملی نموده است. در طراحی و تدوین محتوا برای این گروه از دانش‌آموزان، ضمن توجه به ویژگی‌های شناختی، حسی، جسمی و هیجانی نوآموزان و دانش‌آموزان تلاش گردیده تا ملاحظات ساحت‌های تربیتی حاکم بر فلسفه تعلیم و تربیت که ناظر به رشد و توانمندی دانش‌آموزان برای درک و فهم دانش پایه و عمومی، کسب مهارت‌های دانش‌افزایی، به‌کارگیری شیوه تفکر علمی و منطقی، توان تفکر انتقادی، آمادگی جهت بروز خلاقیت، بینش و تفکر فناورانه برای بهبود کیفیت زندگی است، مورد توجه قرار گیرد تا زمینه‌های مساعد برای به فعلیت رساندن استعدادها و توانایی‌های آنان را فراهم سازد.

سازمان آموزش و پرورش استثنایی بر خود واجب می‌داند از تلاش و مساعی تمامی گروه‌های تألیف کتاب‌های درسی و همکاران سازمان پژوهش و برنامه‌ریزی آموزشی وزارت متبوع که در مراحل چاپ و آماده‌سازی ما را یاری داده‌اند، تقدیر و تشکر نماید. امید است معلمان، کارشناسان و صاحب‌نظران آموزش و پرورش با نظرات و پیشنهادهای ارزشمند خود این سازمان را در ارتقای کیفیت این محتوا یاری رسانند.

معاون وزیر و رئیس سازمان آموزش و پرورش استثنایی کشور

سخنی با همکاران

پس از تدوین سند تحول وزارت آموزش و پرورش و استقرار ساختار جدید آموزشی، سازمان آموزش و پرورش استثنایی نیز همگام با سایر بخش‌های وزارت آموزش و پرورش اقدام به برنامه‌ریزی برای تحقق اهداف سند تحول نموده است. در این راستا، مطابق با اهداف پیش‌بینی شده در برنامه درسی ملی و به منظور کیفیت‌بخشی به آموزش و پرورش دانش‌آموزان با نیازهای ویژه و تحقق عدالت آموزشی و بهبود محتوا و روش‌های آموزشی، در گام نخست کتاب‌های درسی بررسی و ارزشیابی شد. سپس کتاب زبان انگلیسی با توجه به یافته‌های علمی و نیازها و ویژگی‌های دانش‌آموزان دوره اول متوسطه پیش‌حرفه‌ای تألیف شد. امیدواریم با آموزش مناسب این کتاب شاهد پرورش استعدادها و توانمندی‌های دانش‌آموزان عزیز باشیم.

برای پیشبرد بهتر و تکمیل فرایند یاددهی-یادگیری مراجعه همکاران محترم به کتاب راهنمای معلم الزامی است. در ادامه ساختار کتاب به صورت مختصر معرفی می‌شود. شرح مبسوط مطالب در کتاب راهنمای معلم آمده است.

۱. تصویر عنوانی

تصویر عنوانی فضای کلی هر درس را ارائه می‌کند. هدف از تصویر عنوانی ارائه کلی محتوای هر درس و آماده‌سازی ذهن دانش‌آموزان و آشناسازی آنها با مفاهیم آن درس است. پیش از شروع هر درس، معلم با توصیف و ارائه سناریوی درس، انگیزه دانش‌آموزان را برای یادگیری تقویت می‌کند. به این ترتیب توجه دانش‌آموزان گاه به کلیات و گاه به جزئیات تصاویر جلب می‌شود و آگاهی بهتری نسبت به محتوای هر درس پیدا می‌کنند.

۲. متن درس

متن هر درس با تصویر مرتبط و حباب سخن برای دانش‌آموزان ارائه شده است. در این بخش، واژگان هدف در تصویر به صورت موضوعی آورده شده‌اند و سپس به منظور توجه بیشتر دانش‌آموزان به محتوا، نگاره‌هایی نیز به همراه واژگان آورده شده است. برای آشنایی بهتر دانش‌آموزان با داستان کتاب، در هر درس شخصیت‌ها به صورت جداگانه معرفی شده‌اند. لذا آشنایی دانش‌آموزان با نام و تصویر شخصیت‌ها ضروری است.

۳. تمرین

برای توجه به سبک‌های مختلف یادگیری دانش‌آموزان تمرین‌های متنوعی طراحی شده است. صورت دستوری برخی از تمرین‌ها به این قرار است: گوش کنید و تکرار کنید؛ گوش کنید و انجام دهید؛ گوش کنید و بنویسید؛ حروف مشخص را پیدا کنید و دور آنها خط بکشید؛ تصاویر را به حروف ابتدایی‌شان وصل کنید؛ جای خالی اعداد را پر کنید. دانش‌آموزان پس از انجام تمرین به صورت انفرادی، باید در گروه‌های دو یا چندنفره تمرین‌ها را تکرار کنند.

۴. حروف

در هر درس دو حرف به صورت کوچک و بزرگ به دانش‌آموزان آموزش داده می‌شود. تأکید بر این است که در ابتدا نگاره‌های واژه‌های مرتبط معرفی می‌شود تا دانش‌آموزان مفهوم هر واژه را درک کنند. پس از گوش دادن و تکرار کردن دانش‌آموزان به استفاده از حروف در واژگان در قالب «گوش کنید و آواز بخوانید» می‌پردازند.

در بخش تمرین مربوط به حروف، دانش‌آموزان نخست فعالیت‌های فردی را در قالب مهارت شنیداری، وصل کردن تصاویر و بلندخوانی حروف تجربه می‌کنند. سپس فعالیت‌هایی را در قالب کار گروهی انجام می‌دهند. در بخش تمرین نوشتاری الگوهای صحیح نوشتاری حروف تدریس شده به صورت بزرگ و کوچک آورده شده است. به منظور تدریس نوشتار حروف، نحوه چرخش دست برای نوشتن هر یک از حروف آورده شده است و از دانش‌آموزان خواسته شده است پس از ردیابی حروف اقدام به نوشتن هر حرف کنند. در بخش نوشتن، دانش‌آموزان پس از ردیابی و تمرین نوشتن حروف به صورت مستقل، می‌توانند جاهای خالی برخی از واژه‌ها را نیز با حروف مناسب پر کنند.

۵. اعداد

اعداد انگلیسی از صفر تا ده به ترتیب مشخصی در کتاب آموزش داده می‌شوند. در هر درس حداقل دو عدد به دانش‌آموزان تدریس می‌شود. دانش‌آموزان پس از گوش دادن و تکرار کردن و شمارش و دایره کشیدن دور عدد درست به سمت انجام فعالیت‌های دو نفره هدایت می‌شوند. در بخش تمرین نوشتن عدد، نحوه چرخش دست و توالی حرکت‌های دست مهم است. صورت تلفظی و نوشتاری اعداد به صورت تک‌نفره و گروهی در قالب تمرین‌های متنوع تمرین می‌شود.

۶. خود ارزیابی

هدف خودارزیابی این است که دانش‌آموزان بتوانند با قضاوت در مورد مطالب آموخته شده حس ارزشمندی و اعتماد به نفس بیشتری نسبت به خود پیدا کنند و انگیزه یادگیری زبان انگلیسی در آنها تقویت شود. به این ترتیب دانش‌آموزان با درج علامت ✓ می‌توانند دانسته‌های خود را تأیید کنند و با انجام تمرین‌های بیشتر نسبت به برطرف کردن نقاط ضعف خود اقدام کنند.

۷. بخش مروری

به منظور تعمیق یادگیری و بررسی دوباره مطالب فراگرفته شده، در انتهای هر دو درس بخش مروری آورده شده است تا دانش‌آموزان به تمرین مجدد مطالب بپردازند.

۸. فرهنگ تصویری

در بخش پایانی کتاب تمامی واژه‌ها و جمله‌ها به صورت فرهنگ تصویری ارائه شده است.

۹. فهرست دستورکارها

برای استفاده بهتر معلمان گرامی تمامی دستورکارهای کتاب به صورت الفبایی همراه با ترجمه آنها ارائه شده است.

۱۰. متن بخش صوتی

متن تمامی فایل‌های صوتی نیز در انتهای کتاب آمده است.

بازخوردها و نظرات سازنده شما گامی مؤثر در ارتقای محتوای آموزشی است.

گروه نویسندگان

Table of Contents

	Vocabulary	Grammar	Pronunciation
Starter			P. 1
Lesson 1: Greetings P. 6	Hello Bye oven, orange, cat, candy Numbers 1 & 2	The verb be: “am” Pronoun: “I” <i>I am ... , and you.</i>	“C c” & “O o” “C” for <i>cat</i> and <i>candy</i> “O” for <i>oven</i> and <i>orange</i>
Lesson 2: My Classroom P. 20	pen, book, bag, desk apple, ant, tiger, tea Numbers 3 & 4	The verb be: “is” Pronoun: “It” Article: “a” <i>It’s a</i>	“A a” & “T t” “A” for <i>apple</i> and <i>ant</i> “T” for <i>tiger</i> and <i>tea</i>
Review 1			P. 32
Lesson 3: Classroom Commands 1 P. 37	look, listen, repeat, read, write ink, ill, hat, horse Numbers 5 & 6	One-word imperative sentences: <i>Look, Listen, Repeat, Read, Write</i>	“I i” & “H h” “I” for <i>ink</i> and <i>ill</i> “H” for <i>hat</i> and <i>horse</i>
Lesson 4: Colors P. 50	red, blue, green, yellow Numbers 7, 8 & 9	The verb be: “is” Pronoun: “It” <i>It’s</i>	“U u” & “B b” “U” for <i>umbrella</i> and <i>up</i> “B” for <i>ball</i> and <i>bed</i>
Review 2			P. 62
Lesson 5: Classroom Commands 2 P. 67	egg, exit, nose, night Numbers 0 & 10	Imperative sentences: <i>Come in, please Sit down, please Stand up, please Go out, please</i>	“E e” & “N n” “E” for <i>egg</i> and <i>exit</i> “N” for <i>nose</i> and <i>night</i>

	Vocabulary	Grammar	Pronunciation
Lesson 6: Fruits P. 80	apple, banana, pear, fig doctor, door, jam, jungle Emergency phone numbers: 110, 115, 118, 123 & 125	The verb be: “is” Pronoun: “It” Articles: “a” / “an” <i>It’s a(n)</i>	“D d” & “J j” “D” for <i>doctor</i> and <i>door</i> “J” for <i>jam</i> and <i>jungle</i>
Review 3			P. 91
Lesson 7: Classroom Commands3 P. 96	open, close, clean, board printer, park, map, money	Imperative sentences: <i>Open the book</i> <i>Close the book</i> <i>Clean the board</i>	“M m” & “P p” “M” for <i>map</i> and <i>money</i> “P” for <i>printer</i> and <i>park</i>
Lesson 8: Animals P. 106	cat, dog, hen, sheep van, volleyball, zipper, zoo	The verb be: “is” Pronoun: “It” Article: “a” <i>It’s a</i>	“V v” & “Z z” “V” for <i>van</i> and <i>volleyball</i> “Z” for <i>zipper</i> and <i>zoo</i>
Review 4			P. 117
Photo Dictionary			P. 122
List of Instructions			P. 126
Worksheet for Letters			P. 130
Audio Scripts			P. 134

Starter



 Listen.



Mina



Sina

Ask the students to find and say the familiar English words (radio, television, cake, and...).



Trace from left to right.

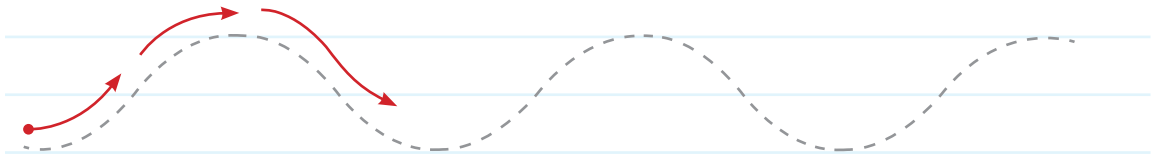

Trace and practice the patterns.

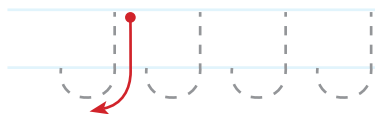

Trace and practice the patterns.

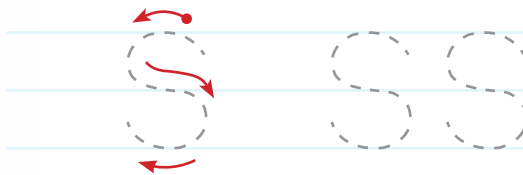
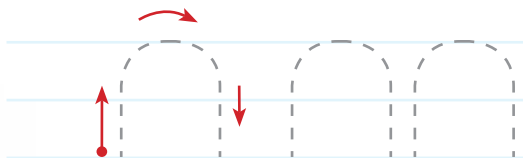
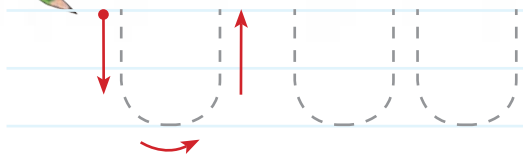

Lesson 1

Greetings



Saying Hello

1 Listen.



2 Listen and repeat.



Mr. Ahmadi



Reza

Ali



Pair work

Ask the students to say "hello" to each other.

Introducing Yourself

3  Listen.



4  Listen and check the correct picture.



1.



2.

5  Listen and point.



Pair work

Ask the students to say "hello" and introduce themselves to each other.

Introducing Yourself

6  Listen.



7  Listen and repeat.



8  Listen and answer.



 Pair work

Ask the students to introduce themselves to each other using the pattern.

I'm, and you?

I'm

Letters: Cc & Oo



9  Listen and repeat.

C c O o

10  Listen and repeat.



cat



orange



candy



oven

11  Listen again and point to the pictures above.

12  Listen and chant.

It's an oven; "o", "o", oven.









It's an orange; "o", "o", orange.

It's a cat; "c", "c", cat.













It's a candy; "c", "c", candy.

Practice

13  Listen and check the correct picture.

  <p>1. <input type="checkbox"/> <input type="checkbox"/></p>	  <p>2. <input type="checkbox"/> <input type="checkbox"/></p>	  <p>3. <input type="checkbox"/> <input type="checkbox"/></p>	  <p>4. <input type="checkbox"/> <input type="checkbox"/></p>
---	---	--	---

14  Listen and choose the correct picture.

1	 <input type="checkbox"/>	 <input type="checkbox"/>	 <input type="checkbox"/>
2	 <input type="checkbox"/>	 <input type="checkbox"/>	 <input type="checkbox"/>
3	 <input type="checkbox"/>	 <input type="checkbox"/>	 <input type="checkbox"/>
4	 <input type="checkbox"/>	 <input type="checkbox"/>	 <input type="checkbox"/>

15  listen and circle.



C / O



C / O

16  Listen and circle the initial letters.

cat

oven

candy

orange

Match the pictures with the initial letters.



Read aloud.

Cc

Oo



Pair work

Point to each picture and ask your friend to name it.







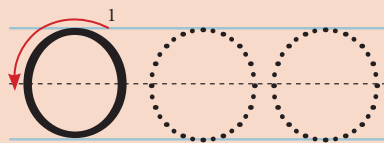
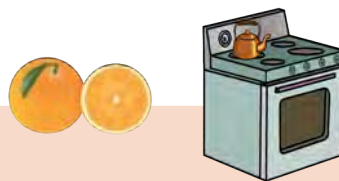
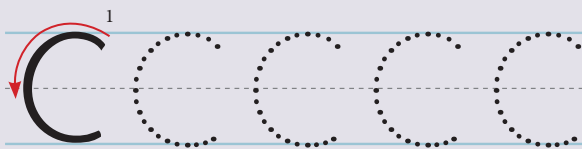







Writing Pad

Trace and write the letters.







Practice

17  Listen and trace.

1			
2			
3			
4			

18  Listen and write the missing letters.

			
1. ...andy	2. ...range	3. ...at	4. ...ven

Look at the pictures and write their initial letters.





Numbers: 1 & 2

19  Listen and repeat.

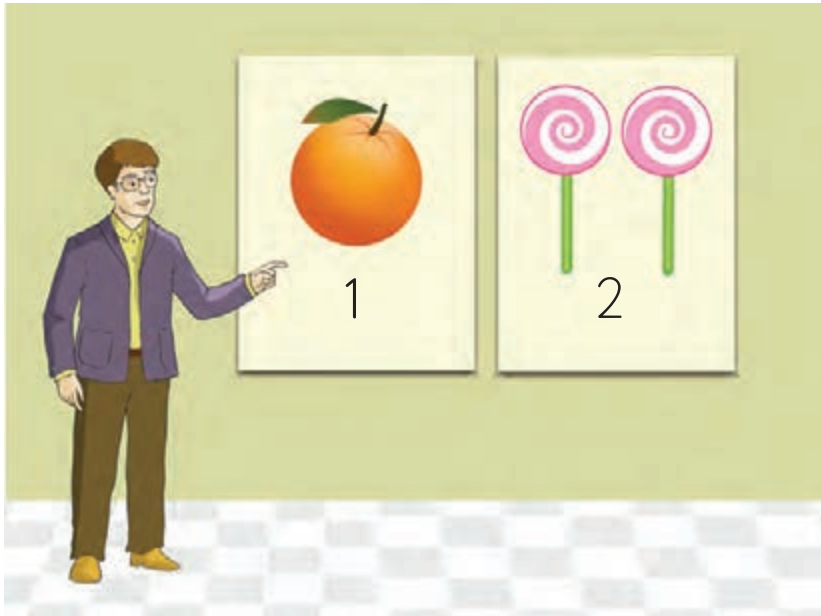

Practice

Circle the correct number.

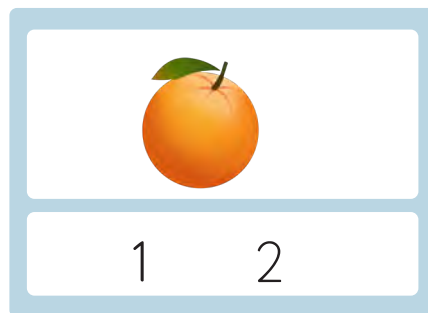
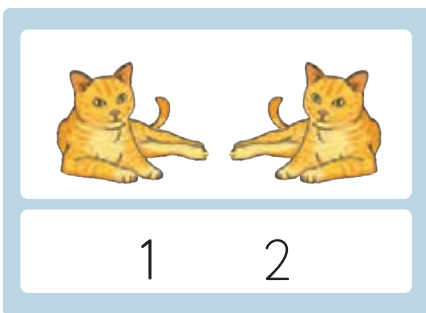

Pair work

Point to each number and ask your friend to say it.

1

2

Writing Pad

Trace and write the numbers.

Handwriting practice for the number 1 on a blue background. The page features three sets of horizontal lines (top, middle dashed, bottom). The first set shows a solid black number 1 with red arrows and numbers 1 and 2 indicating stroke order: a diagonal stroke down from top-left to bottom-right, followed by a vertical stroke down. Next to it is a dotted number 1 for tracing. The second and third sets each contain a single dotted number 1 for tracing.

Handwriting practice for the number 2 on a yellow background. The page features three sets of horizontal lines (top, middle dashed, bottom). The first set shows a solid black number 2 with red arrows and a number 1 indicating stroke order: a curved top stroke, a vertical middle stroke, and a horizontal bottom stroke. Next to it is a dotted number 2 for tracing. The second and third sets each contain a single dotted number 2 for tracing.

Practice

Count and trace.

1		
---	---	---

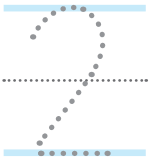
2		
---	---	---

Count and write the numbers.

1		
---	--	--

2		
---	---	---

20  Listen and write.

A



B



Saying Goodbye

21  Listen.



Aa Bb Cc
Dd Ee Ff
Gg Hh Ii
Jj Kk Ll Mm
Nn Oo
Pp Qq Rr
Ss Tt Uu Vv
Ww Xx Yy Zz

Goodbye.





Pair work

Ask the students to say "goodbye" to each other.





Self - Check

Check (✓) your learning.

1. Conversation

2. Vocabulary

3. Letters

C c	O o

4. Numbers

1	2

Lesson 2

My Classroom



Aa Bb Cc
Dd Ee Ff
Gg Hh Ii
Jj Kk Ll Mm
Nn Oo
Pp Qq Rr
Ss Tt Uu Vv
Ww Xx Yy Zz

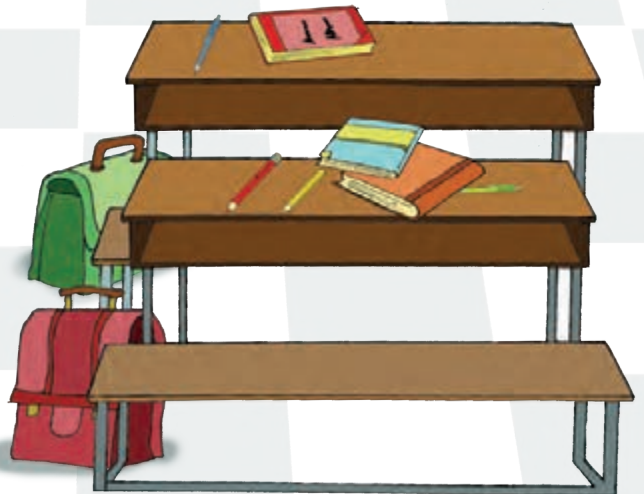
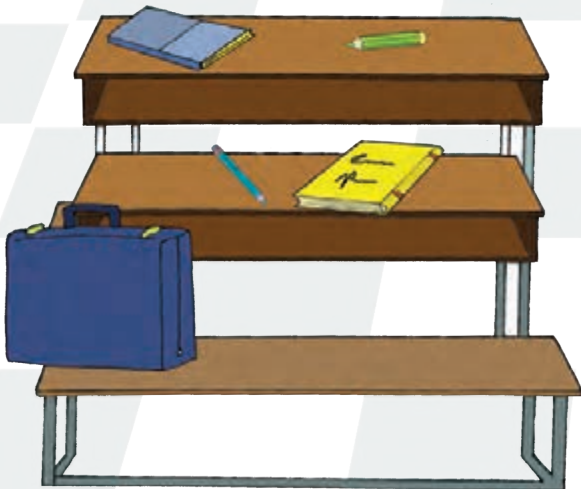

The Classroom

1  Listen.



Aa Bb Cc
Dd Ee Ff
Gg Hh Ii
Jj Kk Ll Mm
Nn Oo
Pp Qq Rr
Ss Tt Uu Vv
Ww Xx Yy Zz

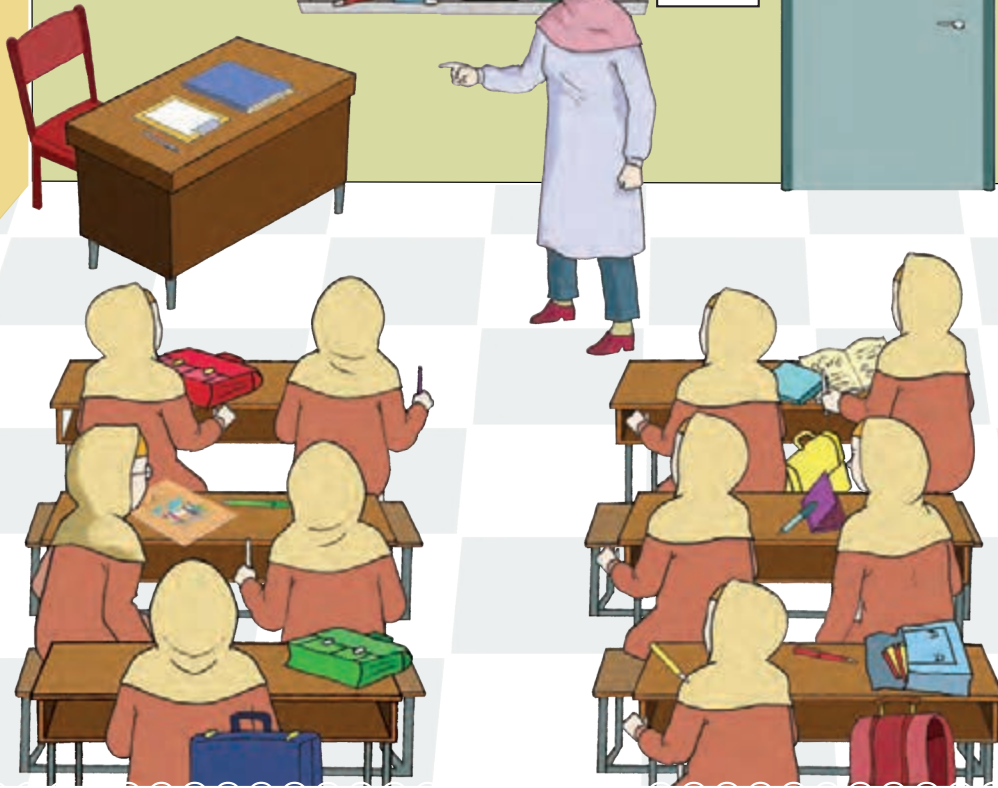

2  Listen and repeat.



desk



bag

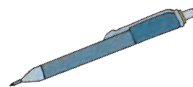

pen



book













Ms. Tavana

Practice

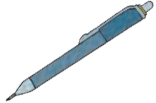
3  Listen and check the correct picture.

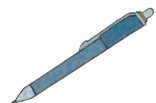
1			2		
	<input type="checkbox"/>	<input type="checkbox"/>		<input type="checkbox"/>	<input type="checkbox"/>
3			4		
	<input type="checkbox"/>	<input type="checkbox"/>		<input type="checkbox"/>	<input type="checkbox"/>

4  Listen and choose the correct picture.

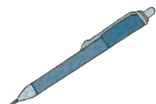
1			
	<input type="checkbox"/>	<input type="checkbox"/>	<input type="checkbox"/>
2			
	<input type="checkbox"/>	<input type="checkbox"/>	<input type="checkbox"/>
3			
	<input type="checkbox"/>	<input type="checkbox"/>	<input type="checkbox"/>
4			
	<input type="checkbox"/>	<input type="checkbox"/>	<input type="checkbox"/>



Pair work

Point to each picture and ask your friend to name it.



Letters: Aa & Tt

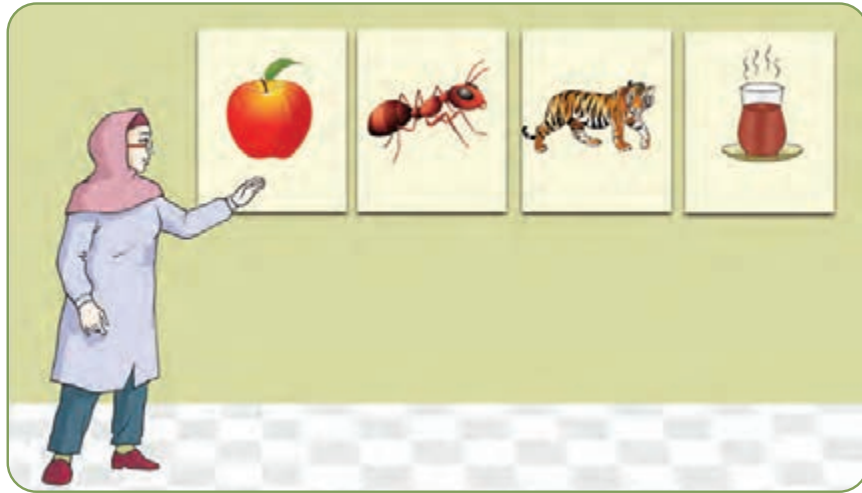

5  Listen and repeat.

A a T t

6  Listen and repeat.



apple



tiger



ant



tea





7  Listen again and point to the pictures above.

8  Listen and chant.

It's an apple; "a", "a", apple.
It's an ant; "a", "a", ant.
It's a tiger; "t", "t", tiger.
It's tea; "t", "t", tea.

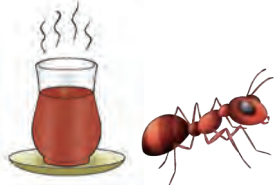
Practice

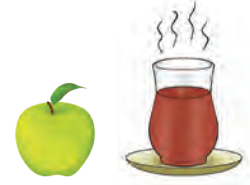
9  Listen and check the correct picture.

 <p>1. <input type="checkbox"/> <input type="checkbox"/></p>	 <p>2. <input type="checkbox"/> <input type="checkbox"/></p>	 <p>3. <input type="checkbox"/> <input type="checkbox"/></p>	 <p>4. <input type="checkbox"/> <input type="checkbox"/></p>
---	---	--	---

10  Listen and choose the correct picture.

1	 <input type="checkbox"/>	 <input type="checkbox"/>	 <input type="checkbox"/>
2	 <input type="checkbox"/>	 <input type="checkbox"/>	 <input type="checkbox"/>
3	 <input type="checkbox"/>	 <input type="checkbox"/>	 <input type="checkbox"/>
4	 <input type="checkbox"/>	 <input type="checkbox"/>	 <input type="checkbox"/>

11  Listen and circle.



a / t



a / t

12  Listen and circle the initial letters.

apple

ant

tiger

tea

Match the pictures with the initial letters.



a

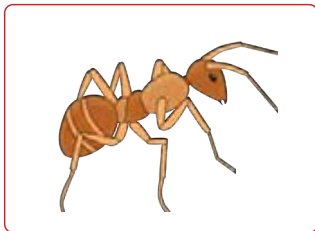

t

Read aloud.

A a T t



Pair work

Point to each picture and ask your friend to name it.







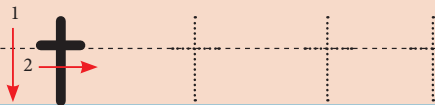
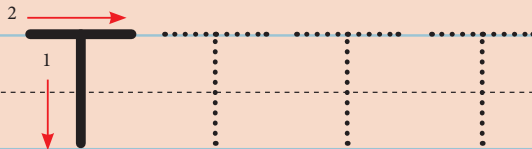







Writing Pad

Trace and write the letters.







Practice

13  Listen and trace.

1			
2			
3			
4			

14  Listen and write the missing letters.

			
1. ...iger	2. ...pple	3. ...ea	4. ...nt

Look at the pictures and write the initial letters.

			
---	---	--	---

Numbers: 3 & 4

15  Listen and repeat.

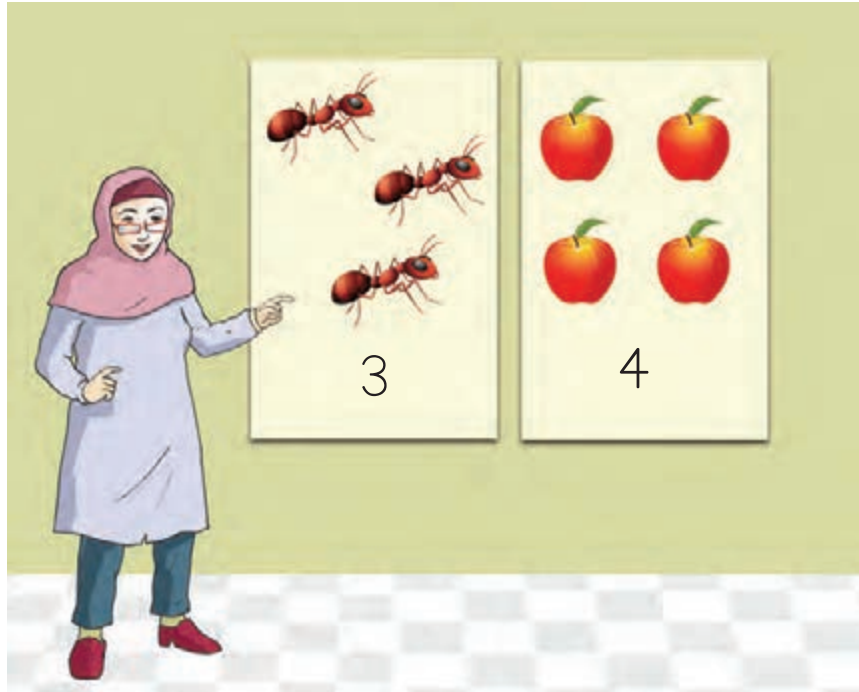

Practice

Count and circle the correct number.

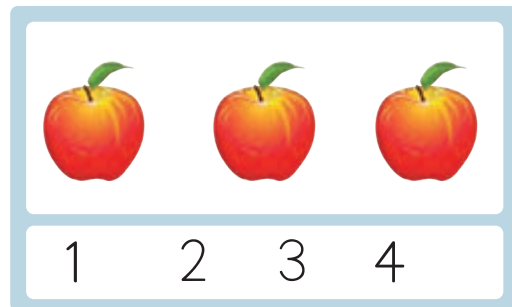
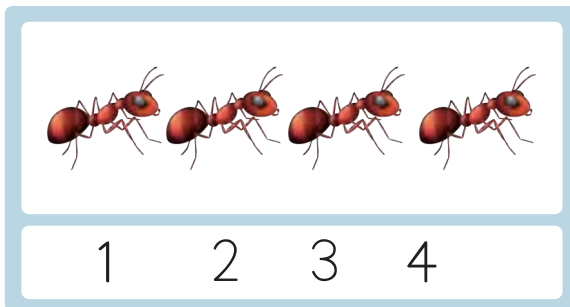

Pair work

Point to each number and ask your friend to read it.

1 2 3 4

Writing Pad



Trace and write the numbers.

This section features a blue background with a spiral binding on the left. It contains three rows of handwriting lines (top, middle dashed, bottom). The first row shows a solid black number '3' with red arrows and numbers '1' and '2' indicating stroke order: a counter-clockwise curve for the top loop, followed by a horizontal line across the middle and a second counter-clockwise curve for the bottom loop. To its right is a dotted '3' for tracing. The second and third rows each contain a single dotted '3' for tracing.

This section features a yellow background with a spiral binding on the left. It contains three rows of handwriting lines (top, middle dashed, bottom). The first row shows a solid black number '4' with red arrows and numbers '1', '2', and '3' indicating stroke order: a vertical line down for stroke 1, a diagonal line from top-left to middle for stroke 2, and a horizontal line from left to middle for stroke 3. To its right is a dotted '4' for tracing. The second and third rows each contain a single dotted '4' for tracing.



Practice

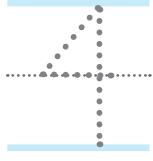

Count and trace.

1		
---	---	---

2		
---	---	---

Count and write the numbers.

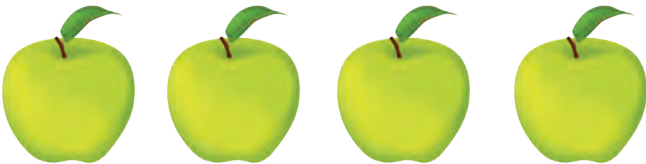
1		
---	--	--

2		
---	---	---

 16 Listen and write.





A		
---	---	--



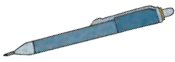

B		
---	---	--

Self - Check

Check (✓) your learning.

1. Vocabulary

2. Letters

A a	T t

3. Numbers

3	4

Review 1

A a Bb **C c** Dd Ee Ff Gg Hh Ii

Jj Kk Ll Mm Nn **O o** Pp Qq

Rr Ss **T t** Uu Vv Ww Xx Yy Zz

1  Listen and check the correct picture.

1



2



3



4



2  Listen and choose the correct picture.

1



2



Match the small letters with the capital letters.

A • • o

C • • t

T • • a

O • • c

Look and circle the initial letters.

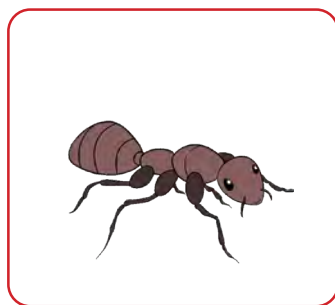

c / a / t



c / a / o



c / t / o



a / t / o

Find and circle the letters “a” and “t”.

bag tiger book ant oven

tea cat apple orange candy

3  Listen and circle the letters.

1. cat

ant

tea

2. orange

tiger

candy

3. apple

oven

tea

4. tiger

apple

oven

Look and write the missing letters.



c...t



...ven

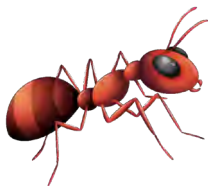

an...



...andy



...ea

4  Listen and write the missing letters.

1. ...range

2. b...g

3. ...iger

4. ...pple

Put the following numbers in the correct order.

2	4	3	1
1

Count and write the numbers.



.....
.....



.....
.....



.....
.....



.....
.....

Lesson 3

Classroom Commands 1



Classroom Commands

1 Listen.



2 Listen and repeat.

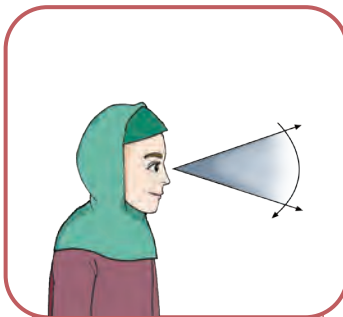

Look



Listen

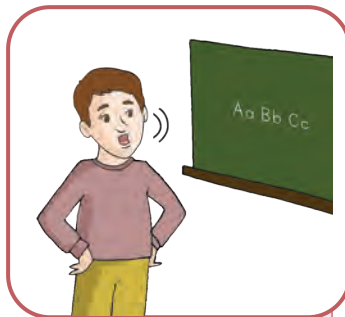

Read



Write

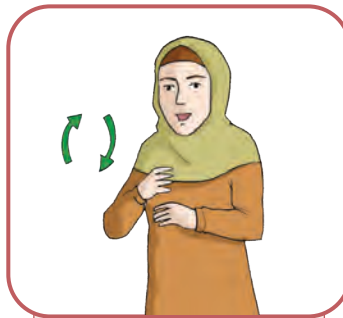



Repeat

3 Listen to the commands above and do what you hear.



Practice

4  Listen and check the correct picture.



1



2

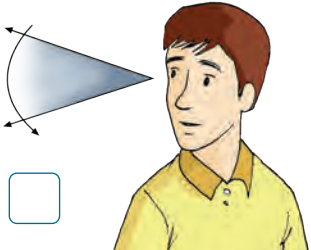

3



4

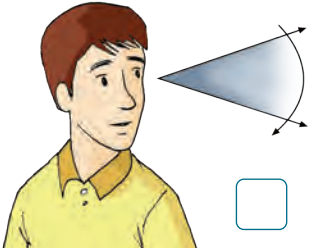

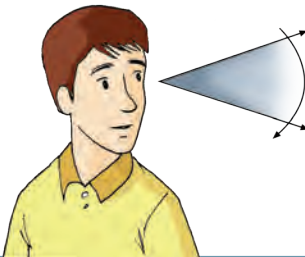
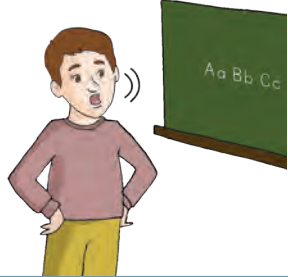

5  Listen and choose the correct picture.

1



2

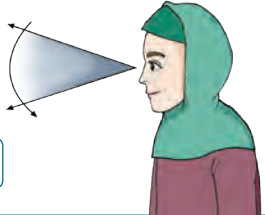

3

4

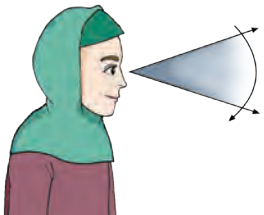
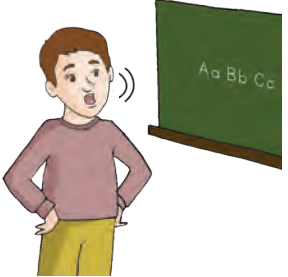
5

Letters: I i & H h



6 Listen and repeat.

I i H h

7 Listen and repeat.



ink



hat



ill

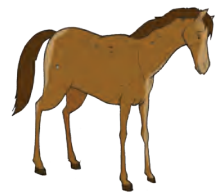

horse

8 Listen again and point to the pictures above.

9 Listen and chant.

It's ink; "i", "i", ink.

He's ill; "i", "i", ill.

It's a hat; "h", "h", hat.













It's a horse; "h", "h", horse.

Practice

10  Listen and check the correct picture.

1	 <input data-bbox="308 511 369 572" type="checkbox"/> <input data-bbox="693 511 754 572" type="checkbox"/>	2	 <input data-bbox="893 511 954 572" type="checkbox"/> <input data-bbox="1278 511 1339 572" type="checkbox"/>
3	 <input data-bbox="308 776 369 838" type="checkbox"/> <input data-bbox="693 776 754 838" type="checkbox"/>	4	 <input data-bbox="893 776 954 838" type="checkbox"/> <input data-bbox="1278 776 1339 838" type="checkbox"/>

11  Listen and choose the correct picture.

1	<input data-bbox="338 1042 400 1103" type="checkbox"/>  <input data-bbox="708 1042 770 1103" type="checkbox"/>  <input data-bbox="1047 1042 1108 1103" type="checkbox"/> 
2	<input data-bbox="338 1287 400 1349" type="checkbox"/>  <input data-bbox="708 1287 770 1349" type="checkbox"/>  <input data-bbox="1047 1287 1108 1349" type="checkbox"/> 
3	<input data-bbox="338 1533 400 1594" type="checkbox"/>  <input data-bbox="708 1533 770 1594" type="checkbox"/>  <input data-bbox="1047 1533 1108 1594" type="checkbox"/> 
4	<input data-bbox="338 1778 400 1839" type="checkbox"/>  <input data-bbox="708 1778 770 1839" type="checkbox"/>  <input data-bbox="1047 1778 1108 1839" type="checkbox"/> 

12  Listen and circle.



i / h

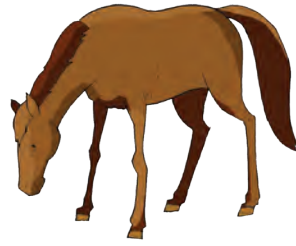

i / h

13  Listen and circle the initial letters.

hat

ink

horse

ill

Match the pictures with the initial letters.

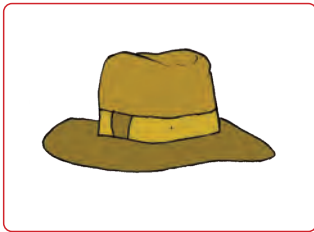

i



h

Read aloud.

I i

H h



Pair work

Point to each picture and ask your friend to name it.

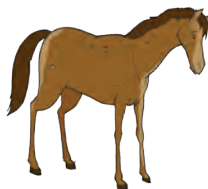





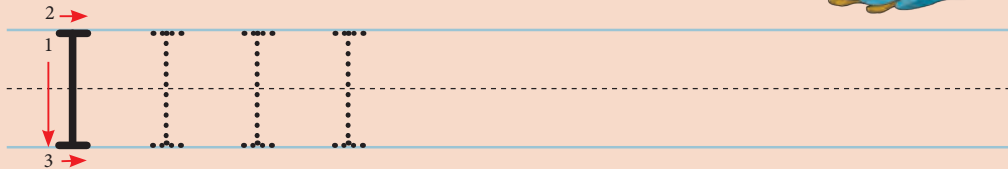
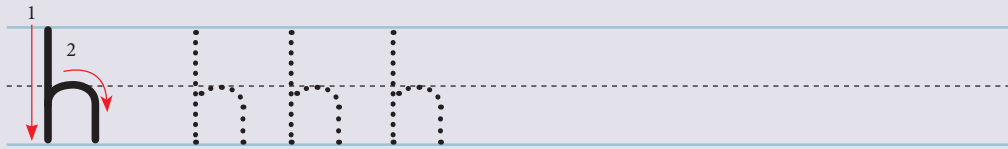
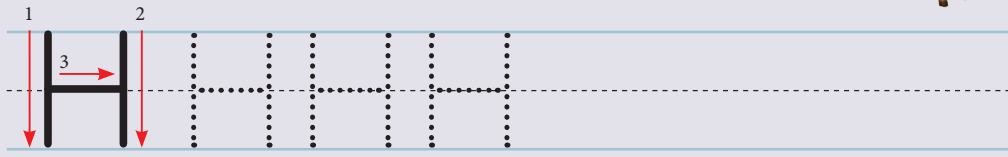
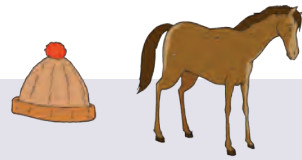

Writing Pad

Trace and write the letters.

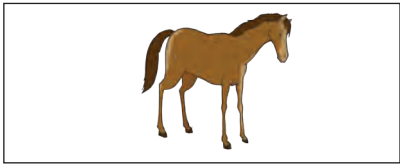
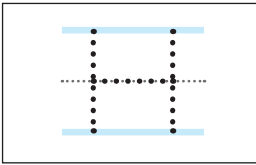
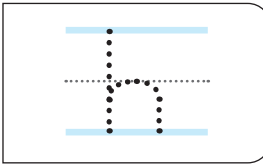

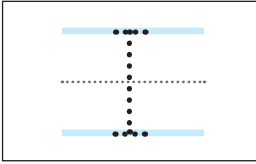
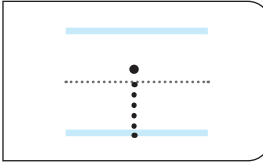
Practice

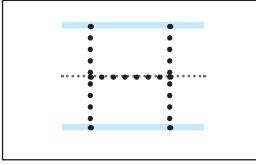
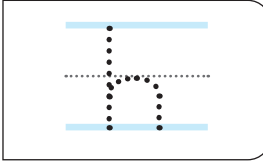
14  Listen and trace.

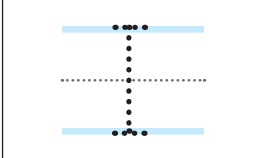
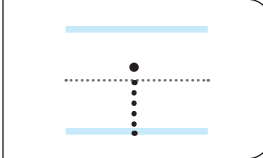
1			
2			
3			
4			

15  Listen and write the missing letters.

			
1. ...nk	2. ...at	3. ...ll	4. ...orse

Look at the pictures and write the initial letters.

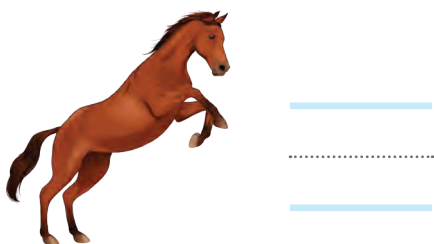

Numbers: 5 & 6

16  Listen and repeat.



Practice

Count and circle the correct number.

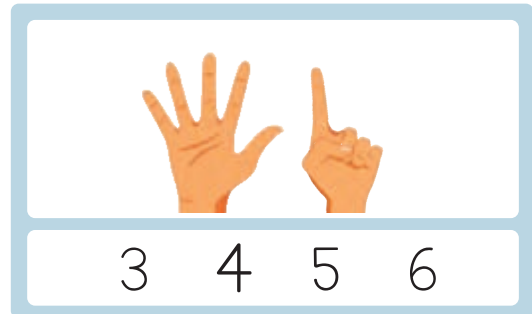
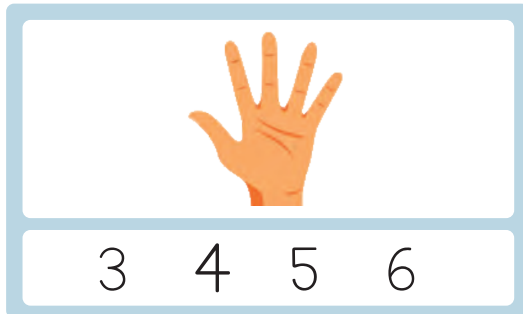

Pair work

Point to each number and ask your friend to read it.

1 2 3 4 5 6

Writing Pad



Trace and write the numbers.

This section features a blue background with a spiral binding on the left. It contains three rows of handwriting lines (top, middle dashed, bottom). The first row shows a solid black number 5 with three numbered arrows indicating stroke order: 1 (horizontal top bar), 2 (vertical stem), and 3 (curved bottom). To its right is a dotted number 5 for tracing. The second and third rows each contain a single dotted number 5 for tracing.

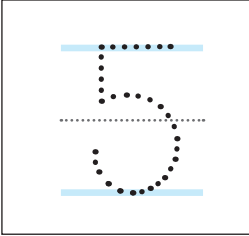

This section features a yellow background with a spiral binding on the left. It contains three rows of handwriting lines (top, middle dashed, bottom). The first row shows a solid black number 6 with two numbered arrows indicating stroke order: 1 (top curve) and 2 (bottom curve). To its right is a dotted number 6 for tracing. The second and third rows each contain a single dotted number 6 for tracing.

Practice

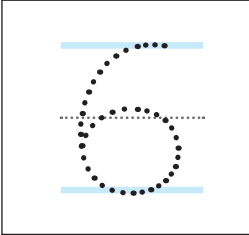
Count and trace.

1		
2		

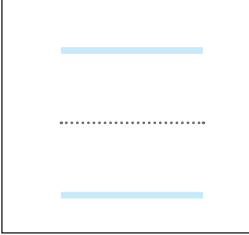
Count and write the numbers.

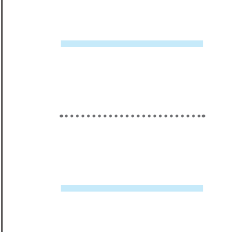
1		
2		





17  Listen and write.

A			
B			



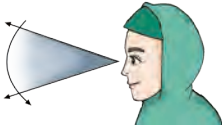

Self - Check

Check (✓) your learning.

1. Commands

2. Vocabulary

3. Letters

l i	H h

4. Numbers

5	6

Lesson 4

Colors

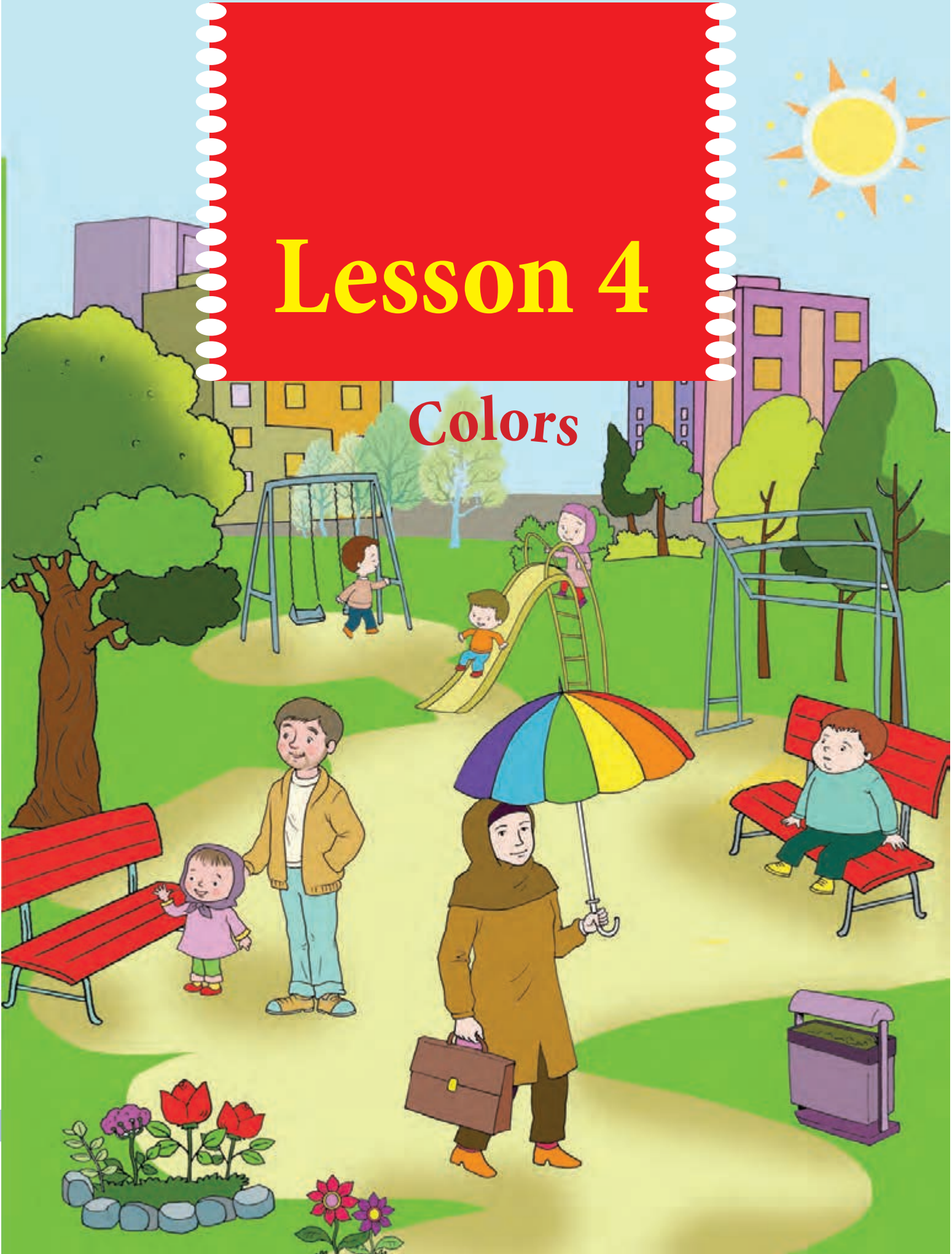

Colors

1 Listen.

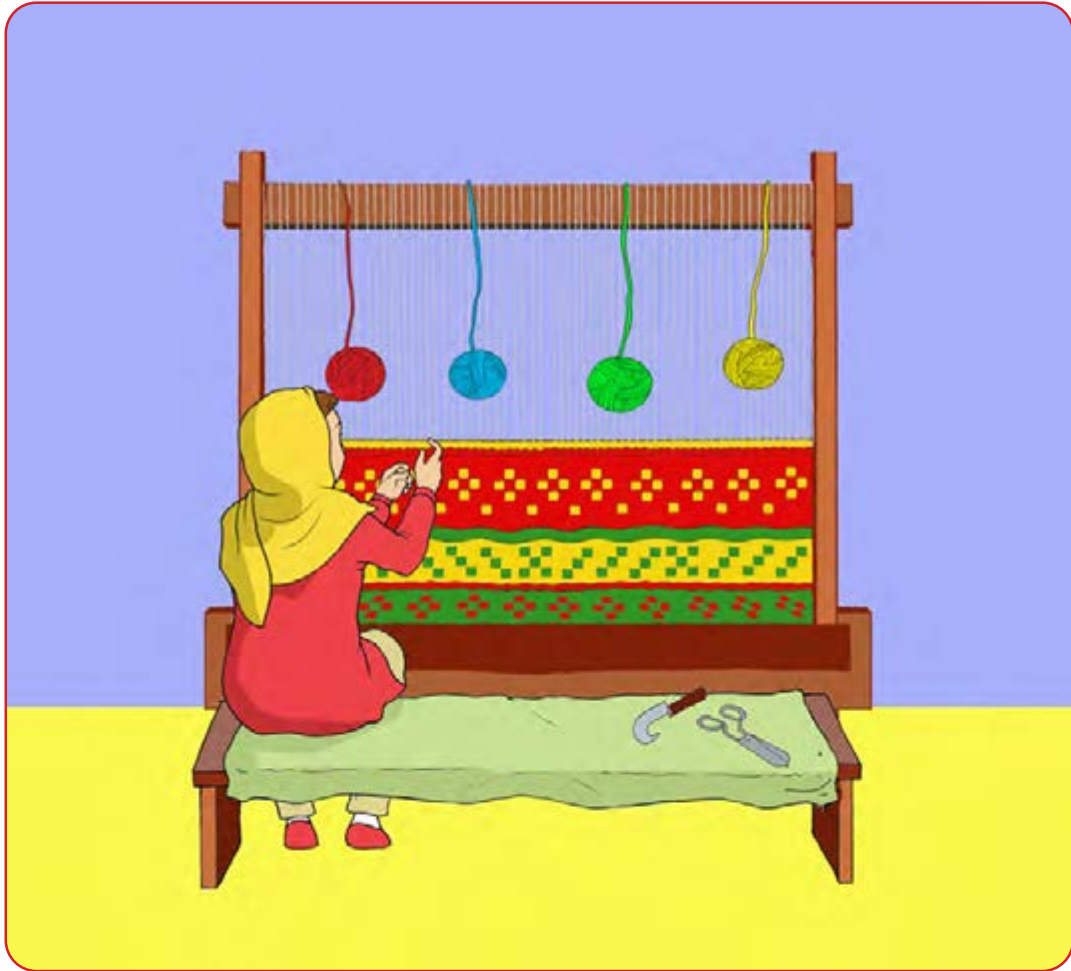

red

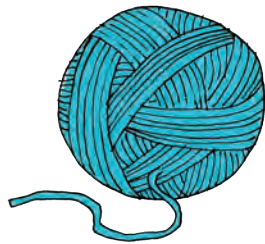

blue



green

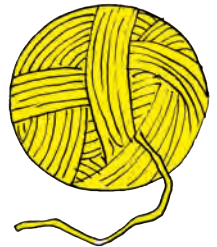









yellow













2 Listen and repeat.

Practice

3  Listen and check the correct picture.

1	 <input type="checkbox"/>	 <input type="checkbox"/>	2	 <input type="checkbox"/>	 <input type="checkbox"/>
3	 <input type="checkbox"/>	 <input type="checkbox"/>	4	 <input type="checkbox"/>	 <input type="checkbox"/>

4  Listen and choose the correct picture.

1	 <input type="checkbox"/>	 <input type="checkbox"/>	 <input type="checkbox"/>	2	 <input type="checkbox"/>	 <input type="checkbox"/>	 <input type="checkbox"/>
3	 <input type="checkbox"/>	 <input type="checkbox"/>	 <input type="checkbox"/>	4	 <input type="checkbox"/>	 <input type="checkbox"/>	 <input type="checkbox"/>

5  Listen and color the pictures.

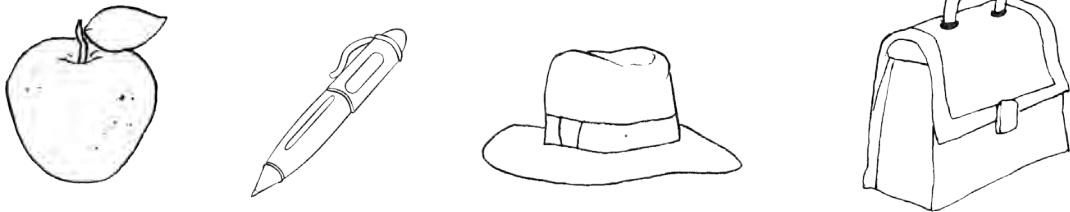

Pair work

Point and name the colors.

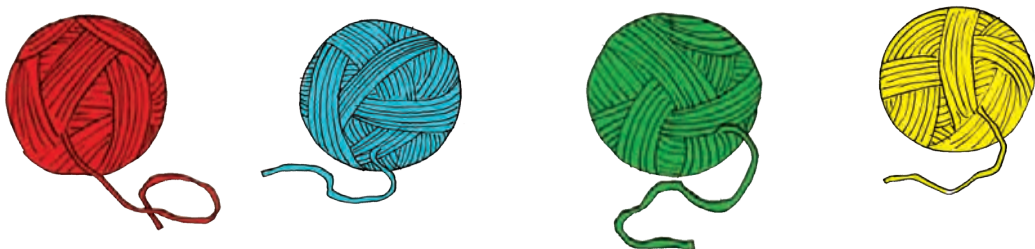

Letters: U u & B b

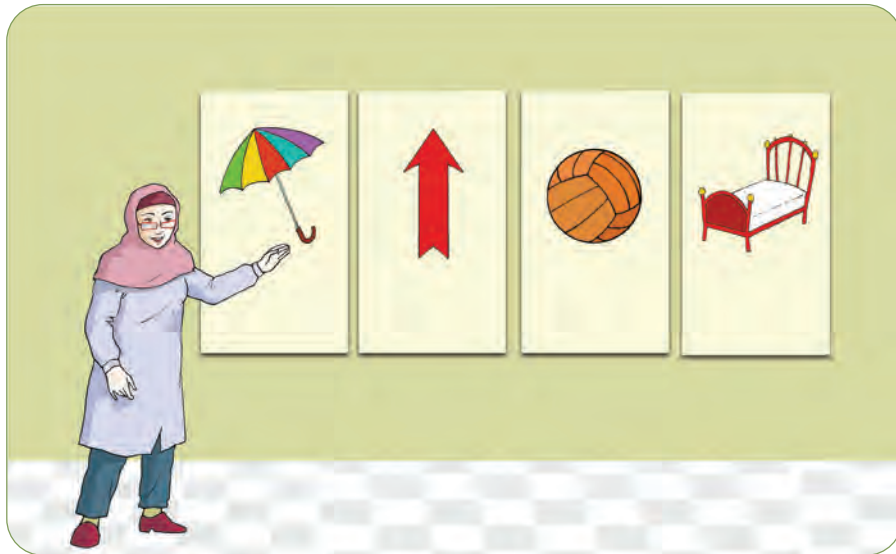

6  Listen and repeat.

U u B b

7  Listen and repeat.



umbrella



ball



up



bed



8  Listen again and point to the pictures above.



9  Listen and chant.



Up; "u", "u", up.
It's an umbrella; "u", "u", umbrella.
It's a ball; "b", "b", ball.
It's a bed; "b", "b", bed.



Practice

10  Listen and check the correct picture.



1  

2  



3  



4  

11  Listen and choose the correct picture.

1   

2   

3   

4   

12  Listen and circle.



u / b



u / b

13  Listen and circle the initial letters.

up

ball

umbrella

bed

Match the pictures with the initial letters.



u



b

Read aloud.

U u

B b



Pair work

Point to each picture and ask your friend to name it.







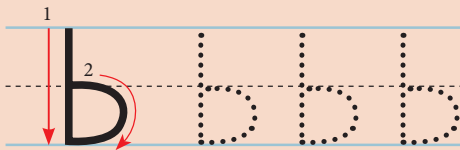
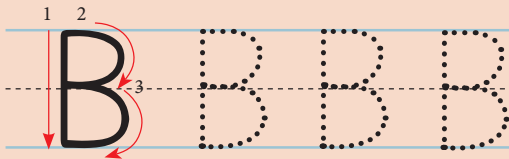
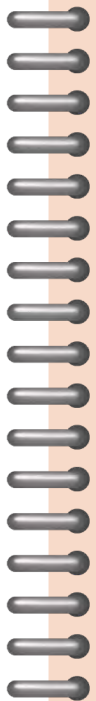
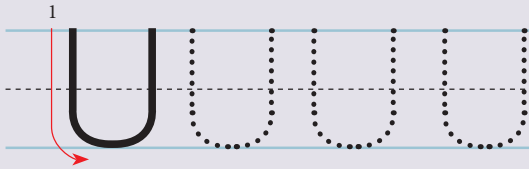
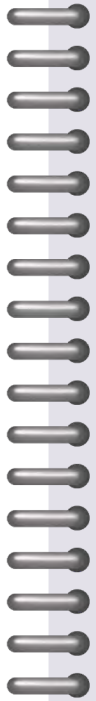





Writing Pad

Trace and write the letters.





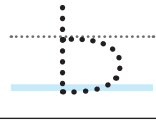

Practice

14  Listen and trace.

1			
2			
3			
4			

15  Listen and write the missing letters.

			
1. ...mbrella	2. ...ed	3.p	4. ...all

Look at the pictures and write the initial letters.

	<hr/> <hr/> <hr/>		<hr/> <hr/> <hr/>
---	-------------------	--	-------------------

Numbers: 7, 8 & 9

16  Listen and repeat.

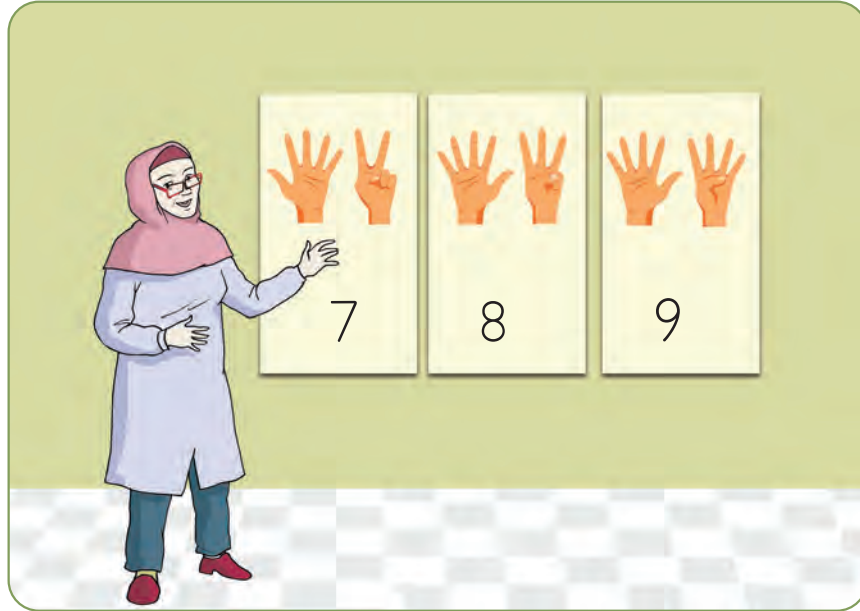

Practice

Count and circle the correct number.

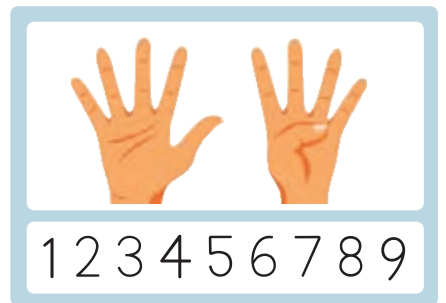
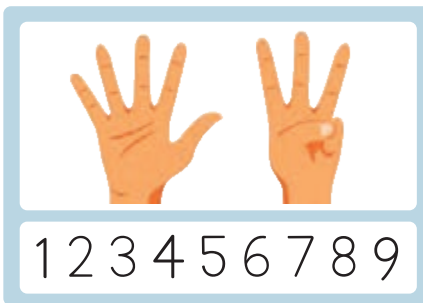
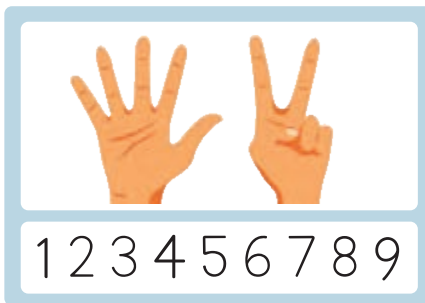

Pair work

Point to each number and ask your friend to read it.

1 2 3 4 5 6 7 8 9

Writing Pad

Trace and write the numbers.



Handwriting practice for the number 7. The first row shows a solid number 7 with stroke order arrows: 1 (horizontal line from left to right) and 2 (diagonal line from top-right to bottom-left). This is followed by two dotted number 7s for tracing. The second row contains a single dotted number 7 for tracing. The background features three horizontal lines: a top solid line, a middle dashed line, and a bottom solid line.

Handwriting practice for the number 8. The first row shows a solid number 8 with stroke order arrows: 1 (top curve), 2 (left vertical line), 3 (bottom curve), and 4 (right vertical line). This is followed by two dotted number 8s for tracing. The second row contains a single dotted number 8 for tracing. The background features three horizontal lines: a top solid line, a middle dashed line, and a bottom solid line.





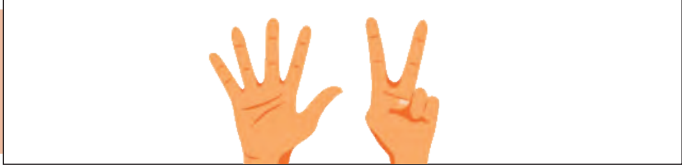
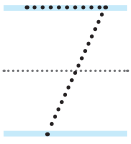
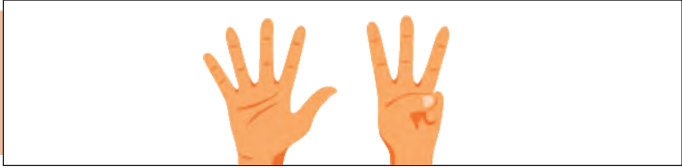
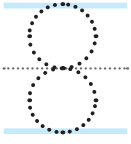

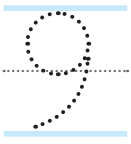
Handwriting practice for the number 9. The first row shows a solid number 9 with stroke order arrows: 1 (top curve) and 2 (vertical line down). This is followed by two dotted number 9s for tracing. The second row contains a single dotted number 9 for tracing. The background features three horizontal lines: a top solid line, a middle dashed line, and a bottom solid line.

Practice





Count and trace.

1		
2		
3		

Count and write the numbers.

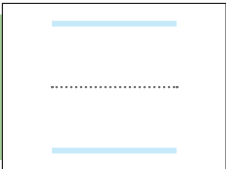
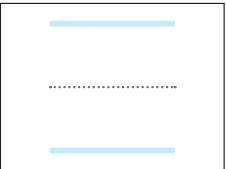
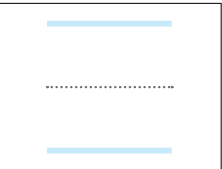
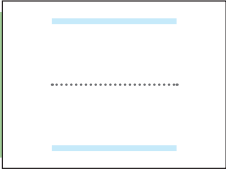
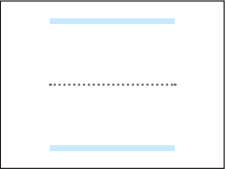
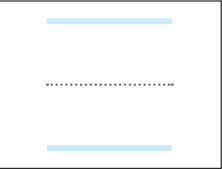
1		
2		
3		





 Listen and write.





A			
B			
C			

Self - Check

Check (✓) your learning.

1. Vocabulary

2. Letters

U u	B b

3. Numbers

7	8	9

Review 2

A a Bb Cc Dd Ee Ff Gg Hh Ii

Jj Kk Ll Mm Nn Oo Pp Qq

Rr Ss Tt Uu Vv Ww Xx Yy Zz

1 Listen and check the correct picture.

1

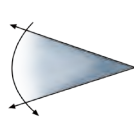

2



3



4

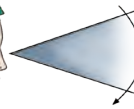

2 Listen and choose the correct picture.

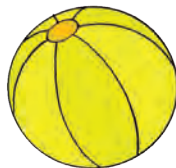
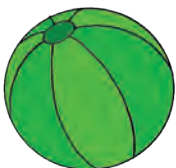

Match the small letters with the capital letters.

U • • b

H • • i

B • • u

I • • h

Look and circle the initial letters.



b / i / h

h / b / u

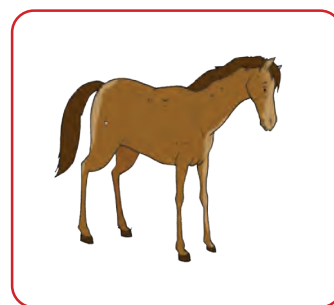
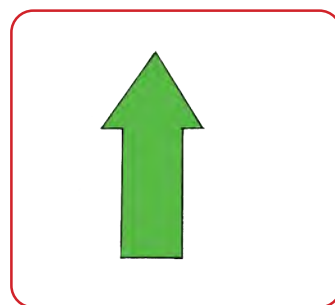

u / b / h

i / u / h

Find and circle the letters "h" and "b".

horse bed ink ill

hat ball up umbrella

3 Listen and circle the letters in each word.

1. up

umbrella

blue

2. ink

ill

listen

3. horse

hat

eight

4. bed

book

ball

Look and write the missing letters.



um ... rella

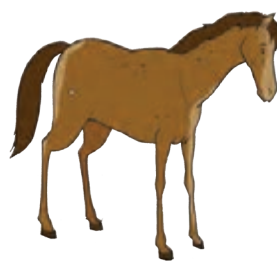

... orse



... nk



... all



Listen and write the missing letters.

1. ...ed

2. ...p

3.at

4. ...ll

Put the following numbers in the correct order.

2	9	3	5	4	8	6	7	1
1	2

Write the missing numbers.

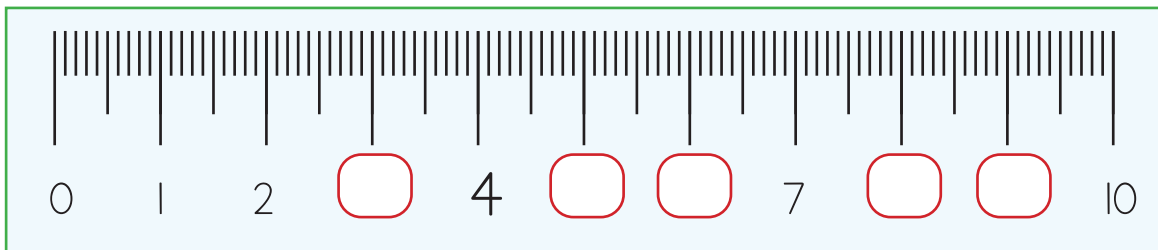

Lesson 5

Classroom Commands 2

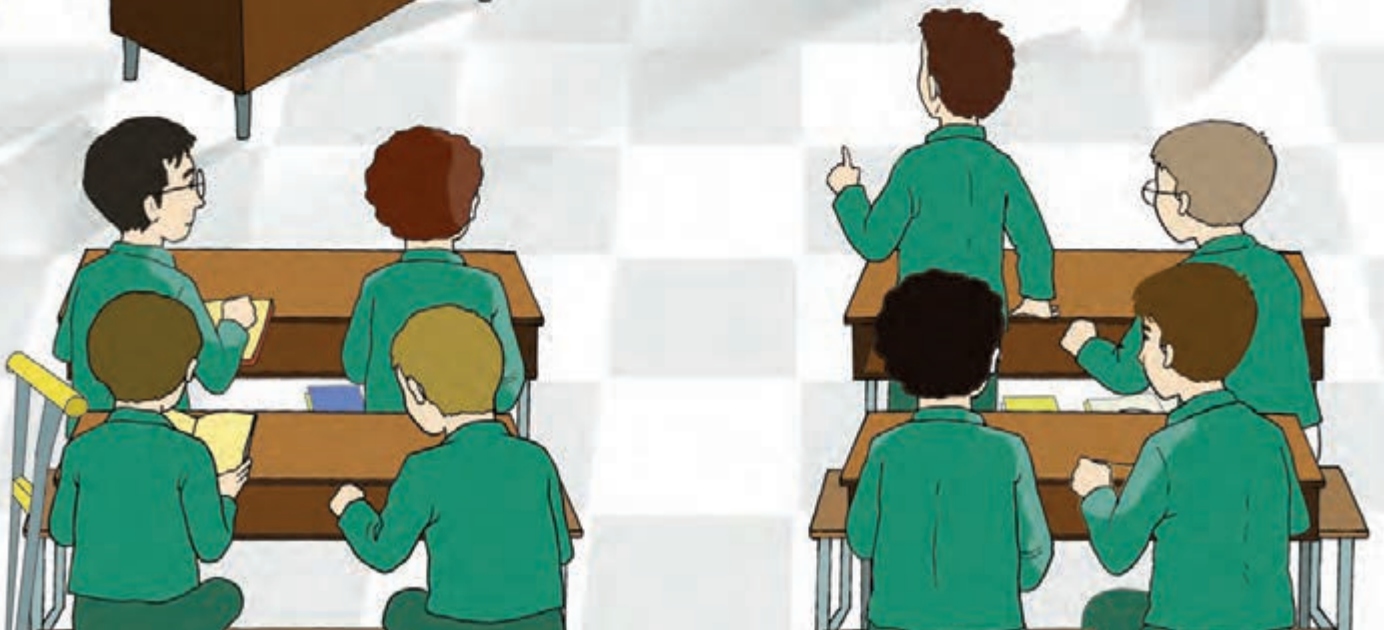
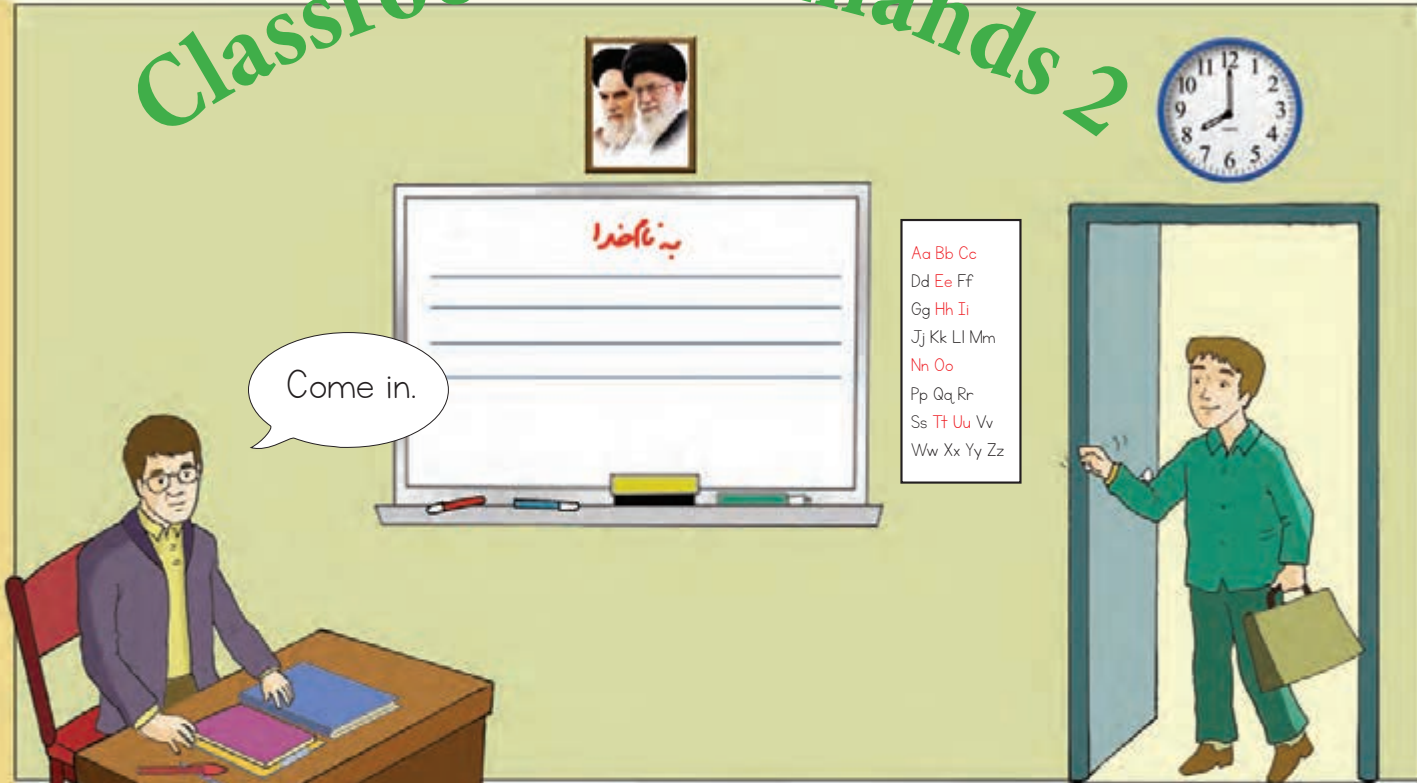

Classroom Commands

1 Listen.

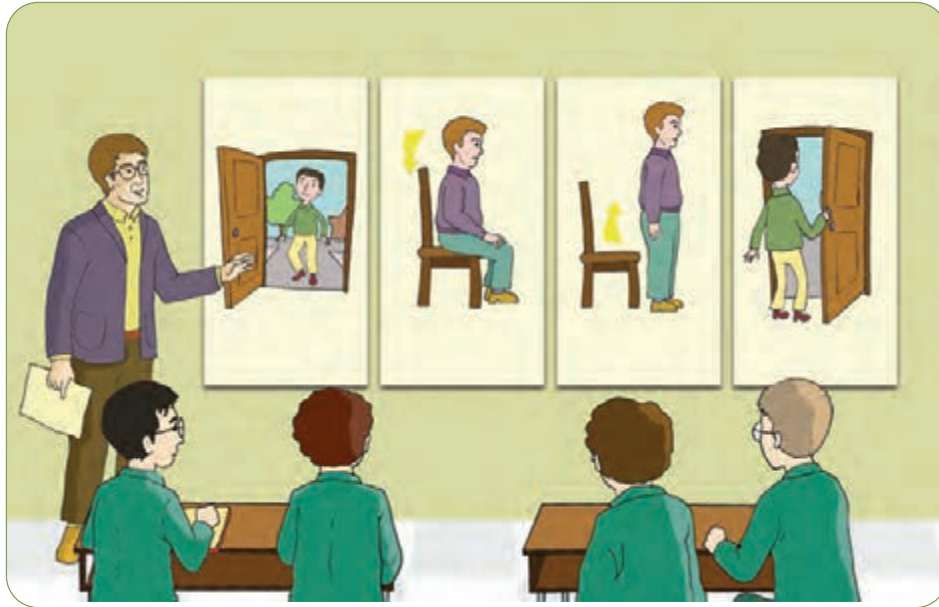

2 Listen and repeat.



Come in, please.



Go out, please.

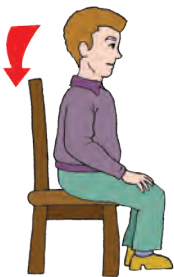

Sit down, please.





Stand up, please.

3 Listen to the commands above and act out what you hear.

Practice

4 Listen and check the correct picture.

1



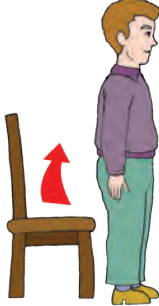
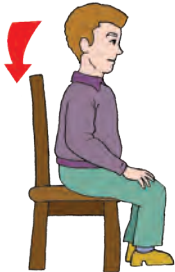

2

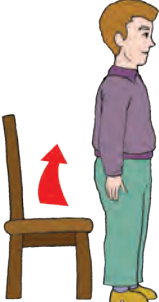

3



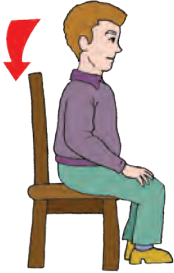

4





5  Listen and choose the correct picture.

1



2

3

4

6  Listen and act out.



Pair work

Ask your friend to act out the commands.

Letters: E e & N n

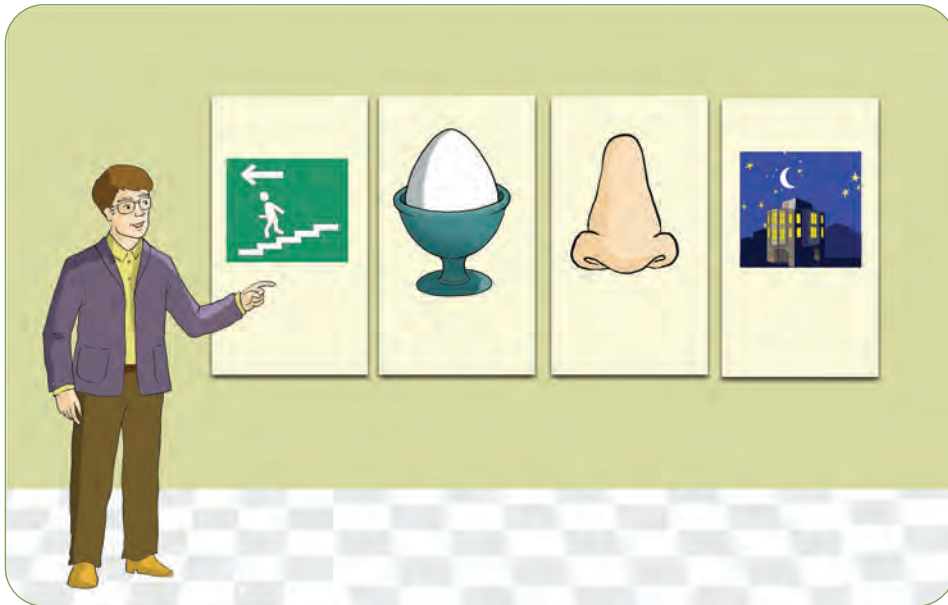

7 Listen and repeat.

E e N n

8 Listen and repeat.



egg



nose



exit



night

9 Listen again and point to the pictures above.

10 Listen and chant.

It's an egg; "e", "e", egg.
It's an exit; "e", "e", exit.
It's a nose; "n", "n", nose.
It's night; "n", "n", night.

Practice

11) Listen and check the correct picture.

1			<input type="checkbox"/>	<input type="checkbox"/>
2			<input type="checkbox"/>	<input type="checkbox"/>
3			<input type="checkbox"/>	<input type="checkbox"/>
4			<input type="checkbox"/>	<input type="checkbox"/>

12) Listen and choose the correct picture.

1	<input type="checkbox"/>		<input type="checkbox"/>		<input type="checkbox"/>	
2	<input type="checkbox"/>		<input type="checkbox"/>		<input type="checkbox"/>	
3	<input type="checkbox"/>		<input type="checkbox"/>		<input type="checkbox"/>	
4	<input type="checkbox"/>		<input type="checkbox"/>		<input type="checkbox"/>	

13  Listen and circle.



e / n



e / n

14  Listen and circle the initial letters.

exit nose egg night

Match the pictures with the initial letters.



e



n

Read aloud.

E e N n



Point to each picture and ask your friend to name it.



Writing Pad

Trace and write the letters.









Handwriting practice for uppercase 'E' and lowercase 'e'. The first row shows a solid uppercase 'E' with stroke order arrows: 1 (vertical down), 2 (top horizontal right), 3 (middle horizontal right), and 4 (bottom horizontal right). This is followed by three dotted uppercase 'E's for tracing. The second row shows a solid lowercase 'e' with stroke order arrows: 1 (horizontal right) and 2 (counter-clockwise curve). This is followed by three dotted lowercase 'e's for tracing. Below each row are two sets of blank handwriting lines (top, middle dashed, bottom) for independent practice.

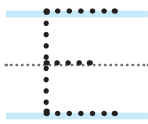
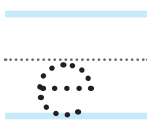

Handwriting practice for uppercase 'N' and lowercase 'n'. The first row shows a solid uppercase 'N' with stroke order arrows: 1 (vertical down), 2 (diagonal down-right), and 3 (vertical down). This is followed by three dotted uppercase 'N's for tracing. The second row shows a solid lowercase 'n' with stroke order arrows: 1 (vertical down) and 2 (curved top). This is followed by three dotted lowercase 'n's for tracing. Below each row are two sets of blank handwriting lines (top, middle dashed, bottom) for independent practice.

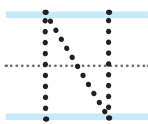
Practice

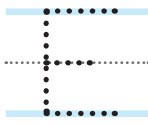
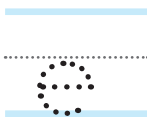
15  Listen and trace.

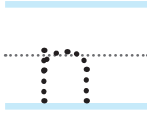
1			
2			
3			
4			

16  Listen and write the missing letters.

			
1. ...gg	2. ...ight	3. ...xit	4. ...ose

Look at the pictures and write the initial letters.





Numbers: 0 & 10

17 Listen and repeat.

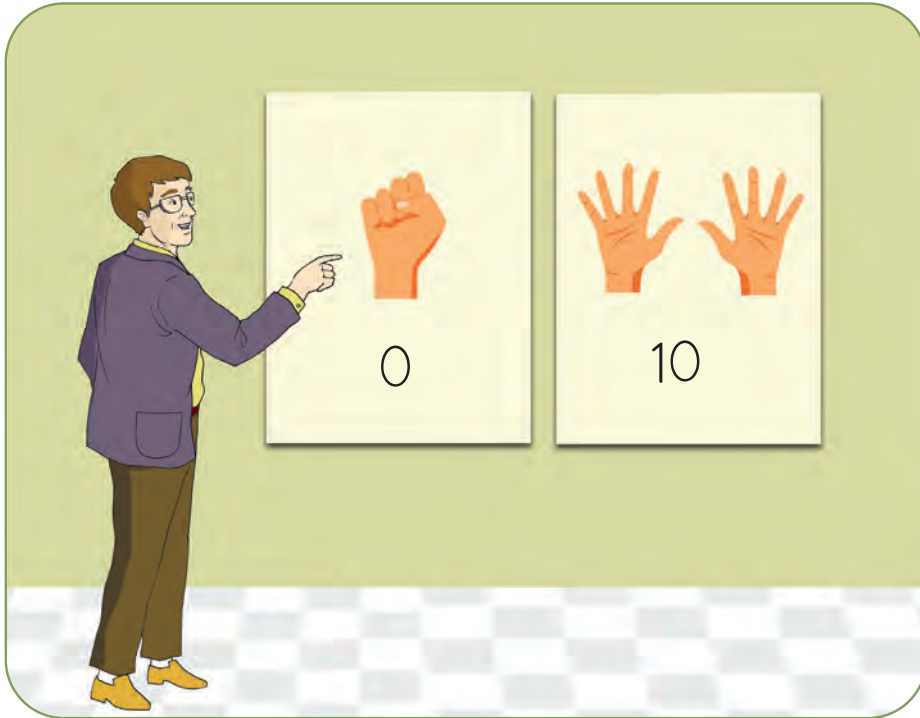

Practice

Count and circle the correct number.

0
1 2
3 4
5 6
7 8
9 10



0
1 2
3 4
5 6
7 8
9 10



Pair work

Point to each number and ask your friend to read it.

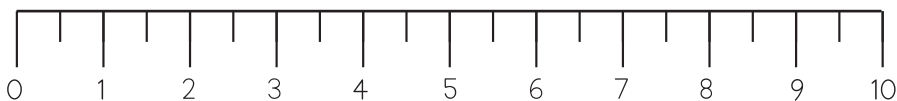

Writing Pad

Trace and write the numbers.

Handwriting practice for the number 0 on a blue background. The page features three rows of horizontal lines (top, middle dashed, bottom). The first row contains a solid black '0' with a red arrow and the number '1' above it, indicating the starting point and direction of the stroke, followed by a dotted '0' for tracing. The second and third rows each contain a single dotted '0' for tracing.

Handwriting practice for the number 10 on a yellow background. The page features three rows of horizontal lines (top, middle dashed, bottom). The first row contains a solid black '10' with red arrows and numbers '1', '2', and '3' indicating stroke order: '1' is a vertical line down (1), '0' is a counter-clockwise circle (2), and the second '0' is a counter-clockwise circle (3). This is followed by a dotted '10' for tracing. The second and third rows each contain a single dotted '10' for tracing.

Practice

Count and trace.

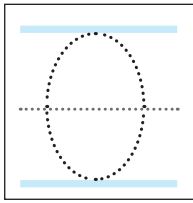
1  

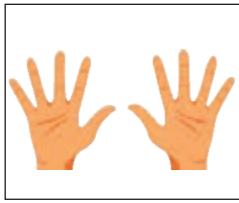
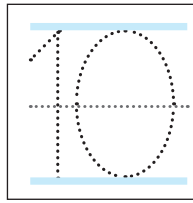
2  

Count and write the numbers.

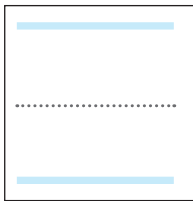
1  

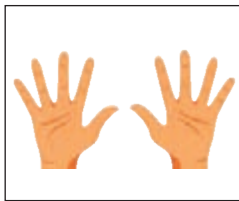
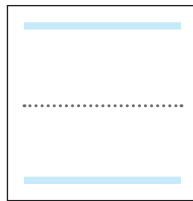
2  



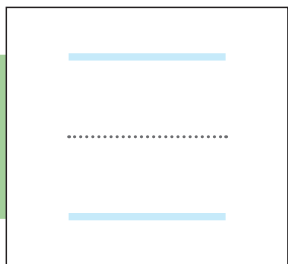
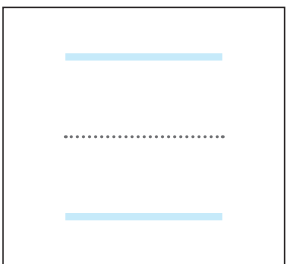
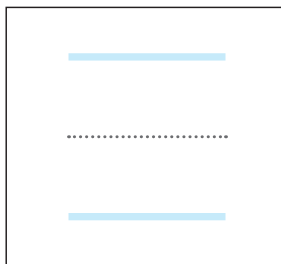
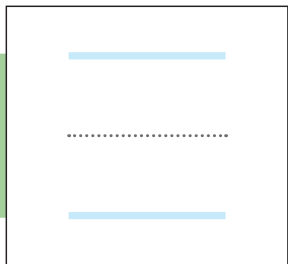
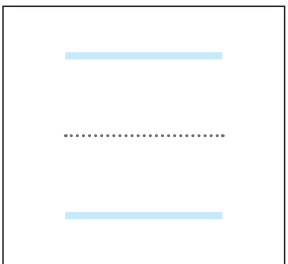
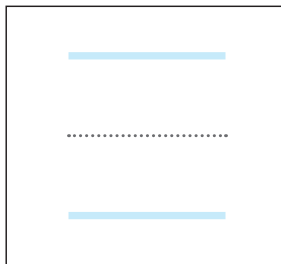
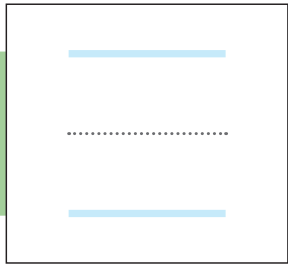
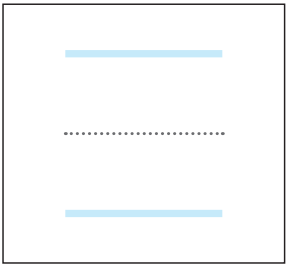
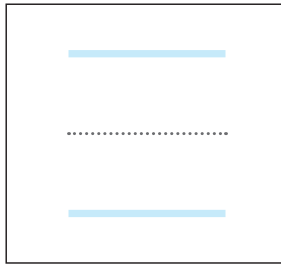
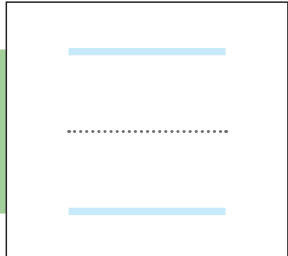
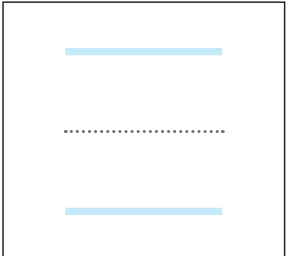
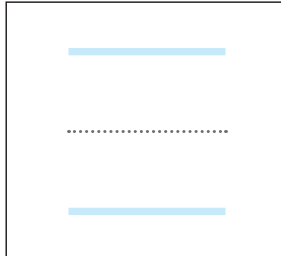

 18 Listen and write.

A			
B			
C			
D			

Self - Check

Check (✓) your learning.

1. Commands

2. Vocabulary

3. Letters

E e	N n

4. Numbers

0	10

Lesson 6

Fruits



Fruits

1 Listen.

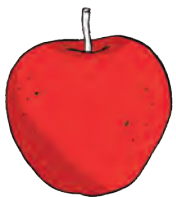

apple

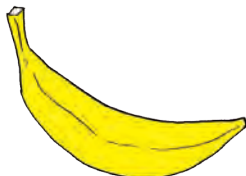

banana

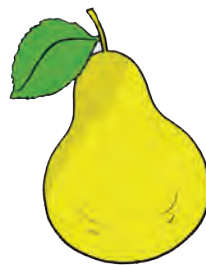

pear





fig

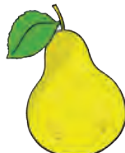

2 Listen and repeat.

Practice

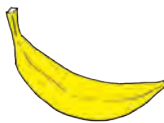
3  Listen and check the correct picture.



1  

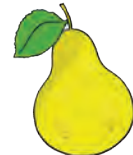

2  

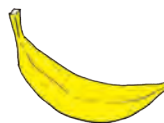

3  

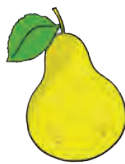

4  

4  Listen and choose the correct picture.

1   

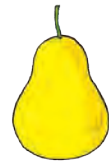
2   

3   

4   



Pair work

Point to each picture and ask your friend to name it.

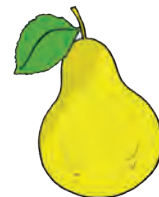
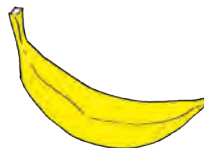

Letters: Dd & Jj



5  Listen and repeat.

D d J j

6  Listen and repeat.



door



jam



doctor



jungle

7  Listen again and point to the pictures above.



8  Listen and chant.

It's a door; "d", "d", door.
He's a doctor; "d", "d", doctor.
It's jam; "j", "j", jam.
It's a jungle; "j", "j", jungle.

Practice

9  Listen and check the correct picture.



1  



2  



3  

4  

10  Listen and choose the correct picture.

1   

2   

3   

4   

11  Listen and circle.



d / j



d / j

12  Listen and circle the initial letters.

door

jungle

doctor

jam

Match the pictures with the initial letters.



j



d

Read aloud.

D d

J j



Pair work

Point to each picture and ask your friend to name it.



Writing Pad

Trace and write the letters.

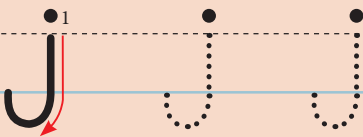
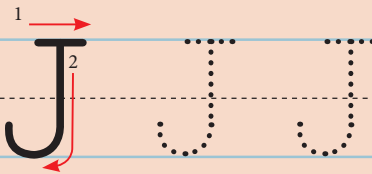
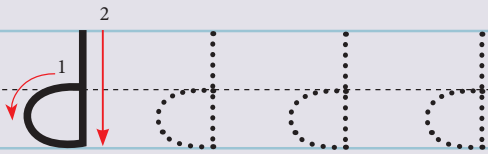
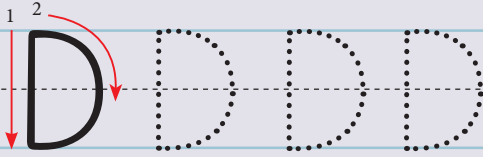

Practice

13  Listen and trace.

1			
2			
3			
4			

14  Listen and write the missing letters.

			
1. ...octor	2. ...ungle	3. ...oor	4. ...am

Look at the pictures and write the initial letters.



.....



.....

Emergency Phone Numbers

15  Listen and repeat.

16  Look and listen.



17  Look, listen and repeat.

125

115

110

118

123

Practice

18  Listen and check the correct item.

1

118	110
<input type="checkbox"/>	<input type="checkbox"/>

2

125	115
<input type="checkbox"/>	<input type="checkbox"/>

19  Listen and circle.

123 115 110 118

20  Listen, write, and say the phone numbers.

12 —

1 — 0

11 —



— 18



12 —

Self - Check

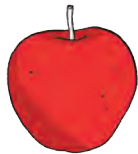
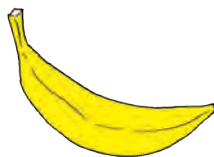
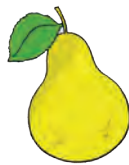
Check (✓) your learning.

1. Vocabulary

2. Letters

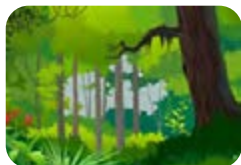
D d	J j

3. Numbers

125	110	115	118	123



Review 3

A a B b C c D d E e F f G g H h I i

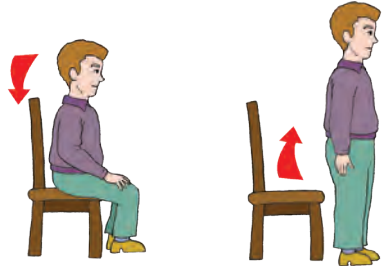
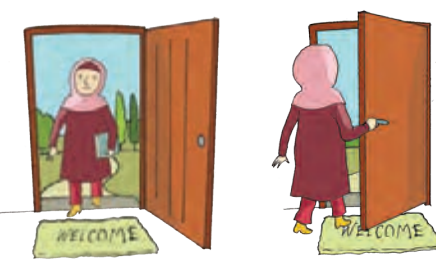

J j K k L l M m N n O o P p Q q

R r S s T t U u V v W w X x Y y Z z

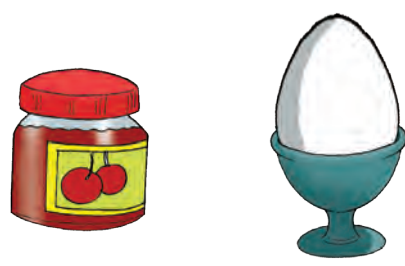
1  Listen and check the correct picture.

1  <input type="checkbox"/> <input type="checkbox"/>	2  <input type="checkbox"/> <input type="checkbox"/>
3  <input type="checkbox"/> <input type="checkbox"/>	4  <input type="checkbox"/> <input type="checkbox"/>

2  Listen and choose the correct picture.

1  <input type="checkbox"/> <input type="checkbox"/> <input type="checkbox"/>
2  <input type="checkbox"/> <input type="checkbox"/> <input type="checkbox"/>

Match the small letters with the capital letters.

D •	• e
E •	• d
J •	• n
N •	• j

Look and circle the initial letters.

	
j / n / e	n / d / e
	
d / e / n	e / j / d

Find and circle the letters “d” and “j”.

door	jungle	nose	doctor	egg
exit	desk	night	umbrella	jam

3  Listen and circle the letters.

- | | | |
|---------|-------|-------|
| 1. oven | night | candy |
| 2. exit | tea | blue |
| 3. red | bed | door |

Look and write the missing letters.



...gg



...ight



...octor



...am



...ose



...oor

4  Listen and write the missing letters.

1. ...xit

2. ...ungle

3. ...ight

4. ...octor

Put the following numbers in the correct order.

0	2	9	1	10	7	6	3	5	8	4
...

5  Listen and check the correct numbers.

A	110	123	B	125	118
	<input type="checkbox"/>	<input type="checkbox"/>		<input type="checkbox"/>	<input type="checkbox"/>

6  Listen and write the correct numbers.

12 —

1 — 3

11 —

— 18

11 —

Lesson 7

Classroom Commands 3



Aa Bb Cc
Dd Ee Ff
Gg Hh Ii
Jj Kk Ll Mm Nn
Oo
Pp Qq Rr
Ss Tt Uu Vv
Ww Xx Yy Zz

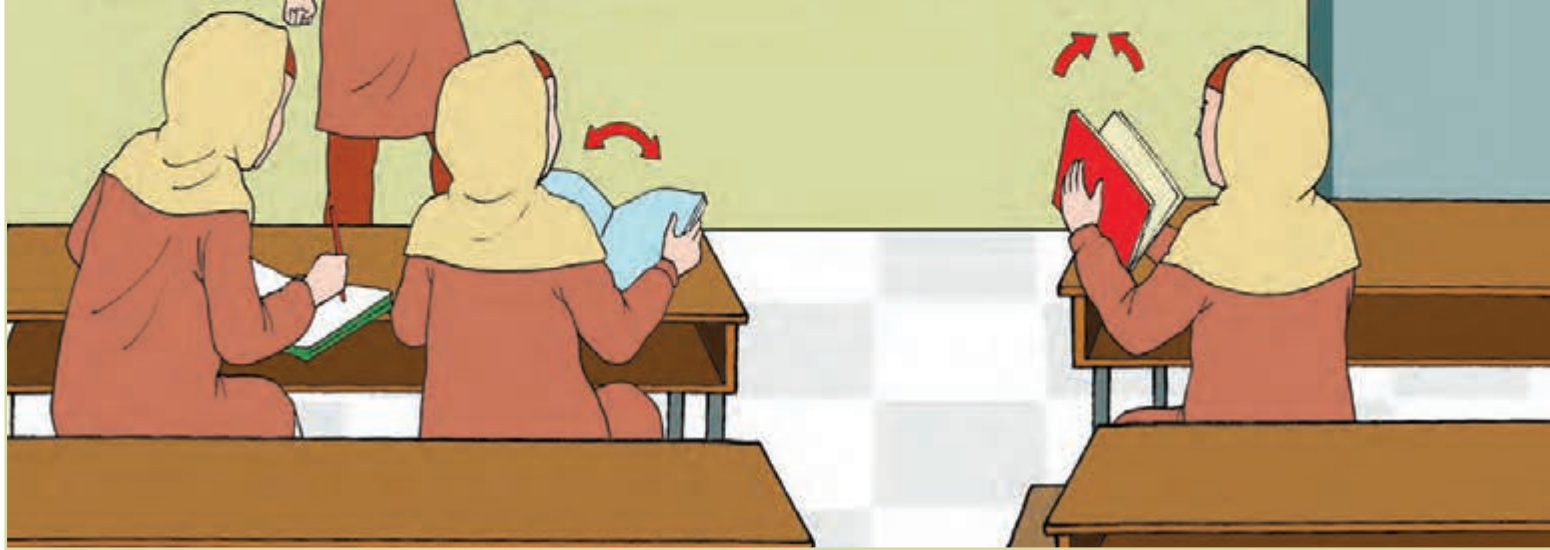

Classroom Commands

1 Listen.



2 Listen and repeat.



Close the book.



Clean the board.







Open the book.



3 Listen to the commands above and act out what you hear.

Practice



4  Listen and check the correct picture.



1  

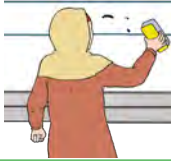

2  

3  

5  Listen and choose the correct picture.

1   

2   

3   

6  Listen and act out.



Pair work

Ask your friend to act out the commands.

Letters: Mm & Pp

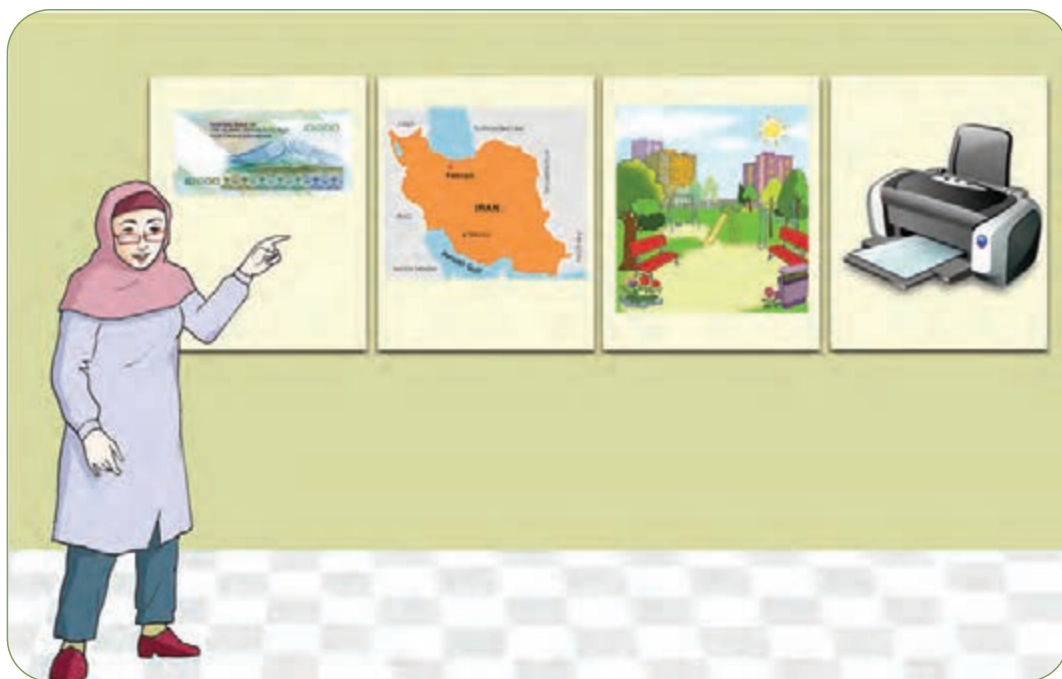

7 Listen and repeat.

M m P p

8 Listen and repeat.



money



park



map



printer

9 Listen again and point to the pictures above.

10 Listen and chant.

It's a map; "m", "m", map.
It's money; "m", "m", money.
It's a printer; "p", "p", printer.
It's a park; "p", "p", park.

Practice

 Listen and check the correct picture.

1



2



3





4





 Listen and choose the correct picture.

1









2







3









4







13  Listen and circle.



p / m



p / m

14  Listen and circle the initial letters.

map park money printer

Match the pictures with the initial letters.



m



p

Read aloud.

M m P p



Point to each picture and ask your friend to name it.







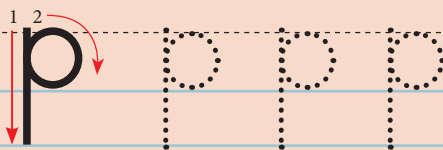
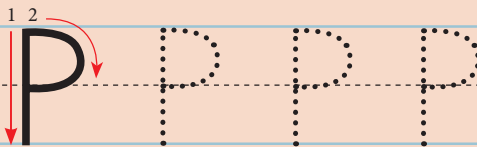
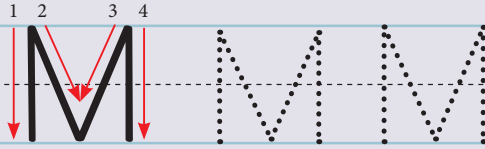



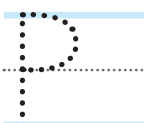

Writing Pad

Trace and write the letters.



Practice

15  Listen and trace.

1			
2			
3			
4			

16  Listen and write the missing letters.

			
1. ...ap	2. ...rinter	3. ...oney	4. ..ark

Look at the pictures and write the initial letters.





Telephone Numbers

Fill the form.

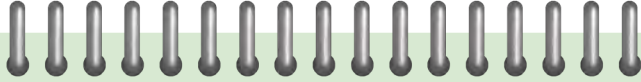

First name :

Last name:

Phone number:

 Listen to the phone numbers and repeat.

8 8 3 0 9 2 6 1

0 2 1 6 6 9 7 1 6 9 5

0 0 9 8 2 1 6 6 9 7 1 5 9 9

Practice



Tell your friend your phone number.

Tell your friend your school telephone number.



 Listen and write the missing numbers.

A	0 8 6 ___ 7 0 ___ 1 4 2 1
B	0 8 7 1 2 ___ 5 0 0 ___ 2

Self - Check

Check (✓) your learning.

1. Commands

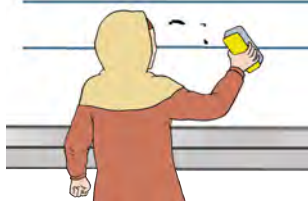
2. Vocabulary

3. Letters

M m	P p

4. Numbers

	88309261

Lesson 8

Animals

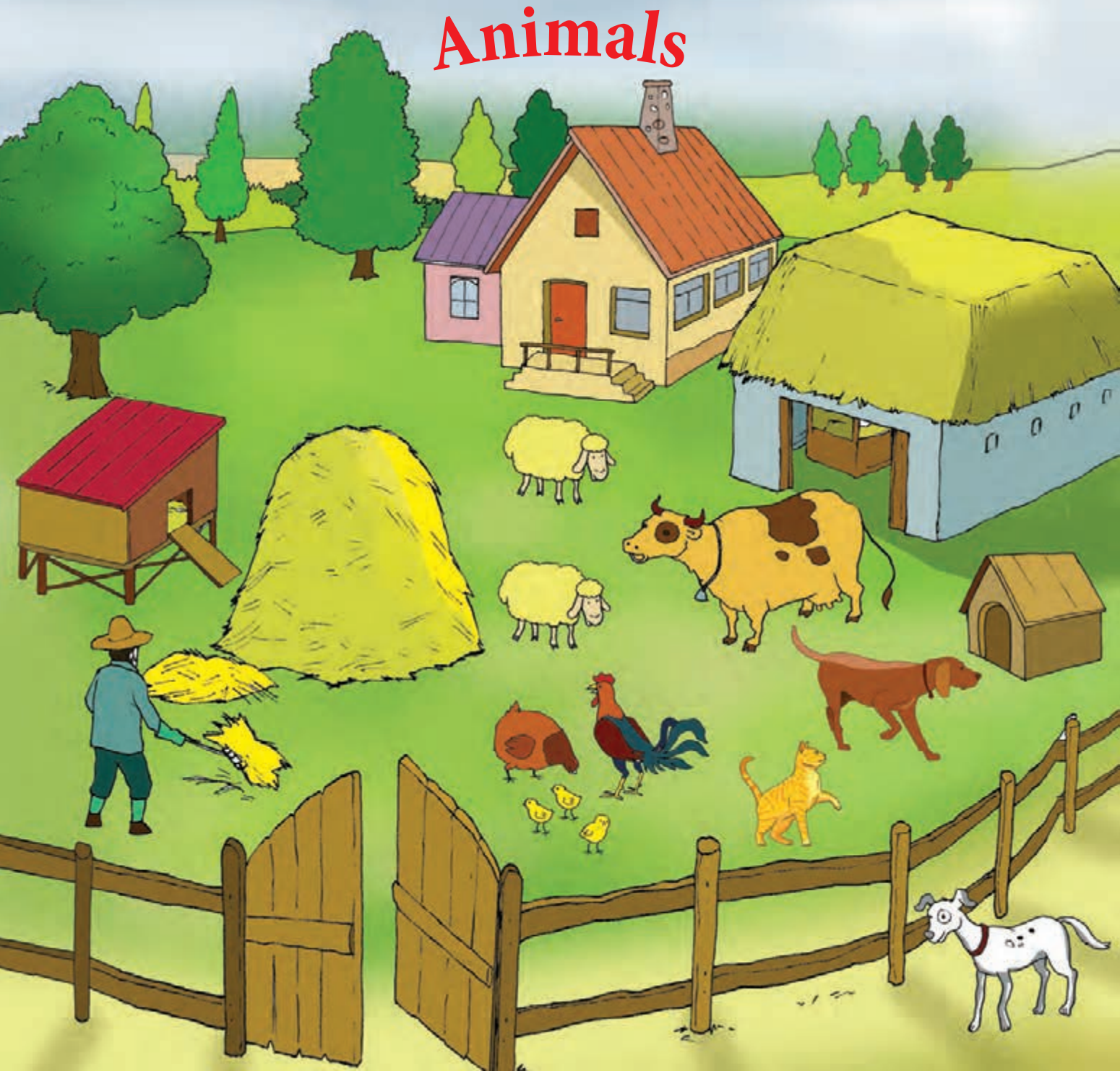

Animals

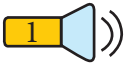
1  Listen.



2  Listen and repeat.



cat

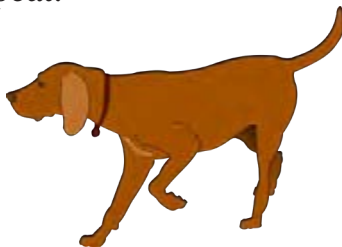

dog



hen

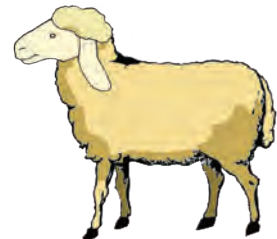



sheep

Practice

3  Listen and check the correct picture.

1  

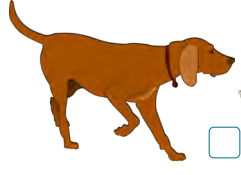

2  

3  

4  

4  Listen and choose the correct picture.

1   

2   

3   

4   



Pair work

Point to each picture and ask your friend to name it.

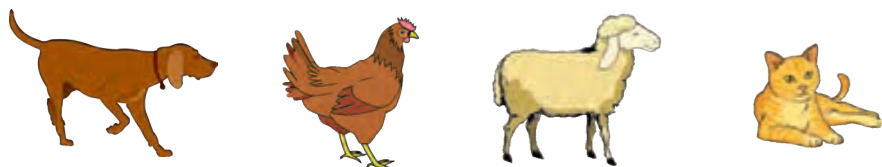

Letters: V v & Z z

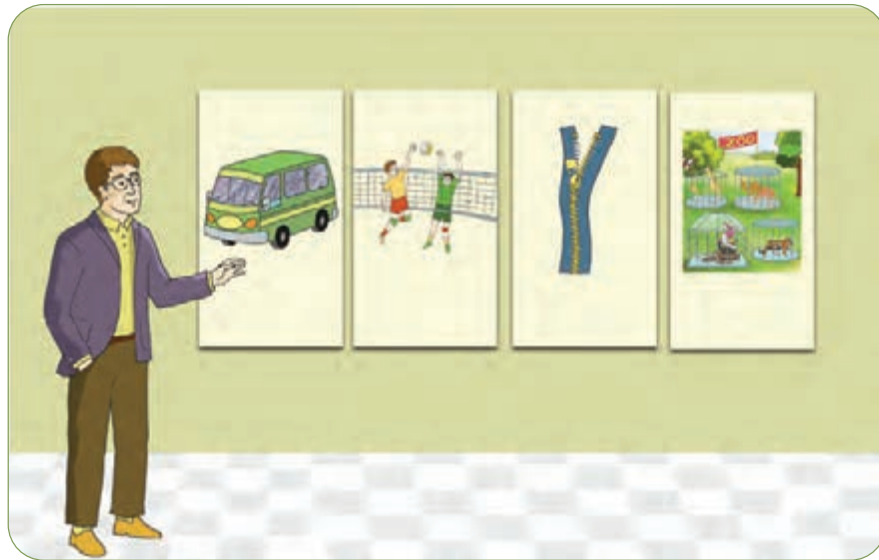

5  Listen and repeat.

V v Z z

6  Listen and repeat.



van



zipper



volleyball

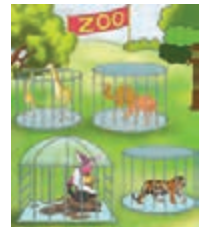

zoo

7  Listen again and point to the pictures above.

8  Listen and chant.

“V”, “v”, volleyball.
It’s a van; “v”, “v”, van.
It’s a zipper; “z”, “z”, zipper.
It’s a zoo; “z”, “z”, zoo.

Practice

9  Listen and check the correct picture.



1 



2 



3 

4 

10  Listen and choose the correct picture.

1   

2   

3   

4   

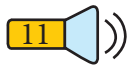

Listen and circle.



v / z



v / z



Listen and circle the initial letters.

zipper

van

zoo

volleyball

Match the pictures with the initial letters.



z

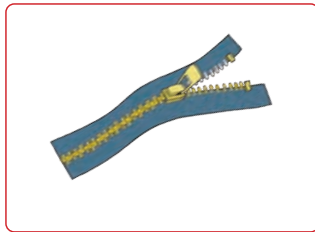

v

Read aloud.

V v

Z z



Pair work

Point to each picture and ask your friend to name it.







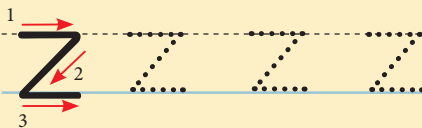
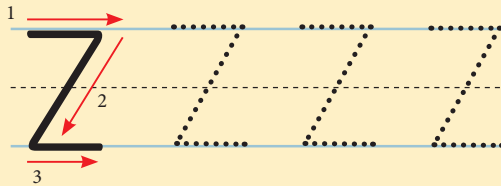
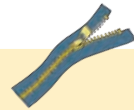
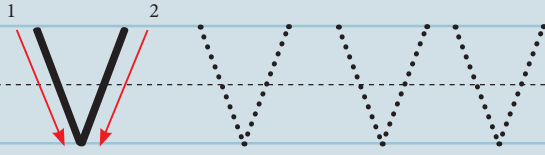



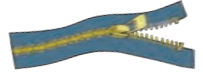
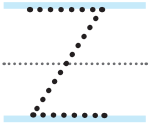

Writing Pad

Trace and write the letters.





Practice

13  Listen and trace.

1			
2			
3			
4			

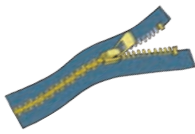
14  Listen and write the missing letters.

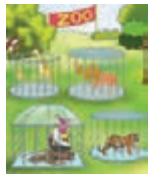
			
1. ...an	2. ...ipper	3. ...olleyball	4. ...oo

Look at the pictures and write the initial letters.





ID Card

15  Look and listen.



A sample ID card with a light blue background and rounded corners. It features a small map of Iran in the top left, a portrait of a man in the middle left, and a green sun-like symbol in the bottom left. The text 'ID CARD' is centered at the top in red. To the right, there is the national emblem of Iran and the text 'جمهوری اسلامی ایران' in Persian. Below the emblem, the ID number '0040210250', first name 'Sina', and last name 'Hasani' are listed.

Complete your ID card.



A blank ID card template with a light blue background and rounded corners. It features a small map of Iran in the top left, a white square for a portrait in the middle left, and a green sun-like symbol in the bottom left. The text 'ID CARD' is centered at the top in red. To the right, there is the national emblem of Iran and the text 'جمهوری اسلامی ایران' in Persian. Below the emblem, there are three input fields for 'ID No:', 'First Name:', and 'Last Name:'.

Practice

 Listen to the following ID numbers and repeat.

0 0 3 0 1 0 2 5 0 9

0 0 4 1 2 5 0 6 8 3







Tell your friend your ID number.

Self - Check

Check (✓) your learning.

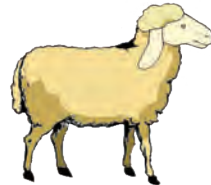
1. Vocabulary



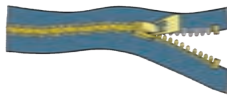
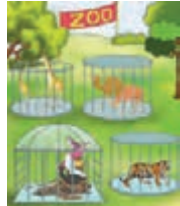

2. Letters

V v	Z z

3. Numbers

 ID CARD جمهوری اسلامی ایران  ID No: 0040210250 First Name: Sina Last Name: Hasani	ID CARD

Review 4

A a B b C c D d E e F f G g H h I i

J j K k L l M m N n O o P p Q q

R r S s T t U u V v W w X x Y y Z z

1  Listen and check the correct picture.

1



2



3



4

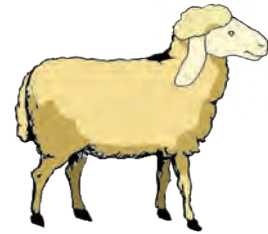

2  Listen and choose the correct picture.

1



2

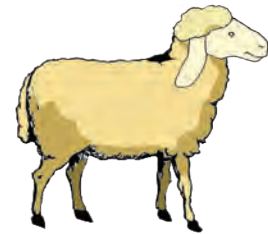

Match the small letters with the capital letters.

M • • p

P • • m

V • • z

Z • • v

Look and circle the initial letters.



p / v / m

m / p / z

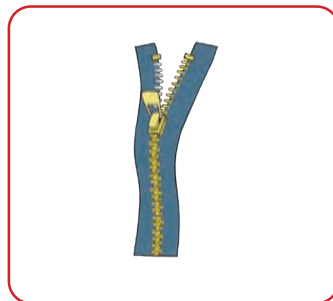

z / v / m

z / p / m

Find and circle the letters “v” and “z”.

van zipper oven zoo volleyball
map park money printer apple

3  Listen and circle the letters.

- | | | |
|---------|------|------------|
| 1. van | oven | volleyball |
| 2. park | pen | up |
| 3. jam | map | umbrella |

Look and write the missing letters.



...ap



...ark



...an



...oo



...olleyball

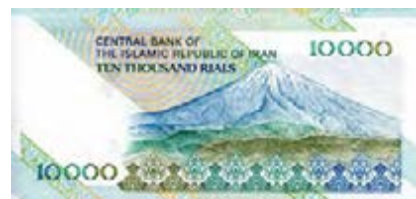

...oney

 Listen and write the missing letters.

1.ipper

2.rinter

3.oney

4.an



Say your phone number and ask your friend to write it down.

Photo Dictionary

Starter



radio



television



cake

Lesson 1



cat



candy



orange



oven

Lesson 2



desk



bag

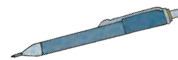

pen



book



apple



ant



tiger



tea

Lesson 3

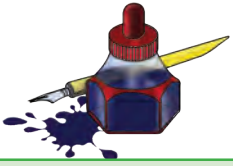

ink



ill



hat



horse

Lesson 4



red



blue



green



yellow



umbrella



up



ball



bed

Lesson 5



egg



exit



nose



night

Lesson 6



apple

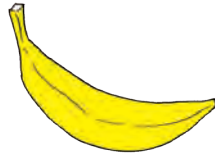

banana



pear



fig



door



doctor



jam



jungle

Lesson 7



money



map



park



printer

Lesson 8



cat

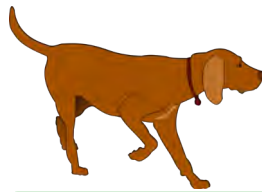

dog



hen

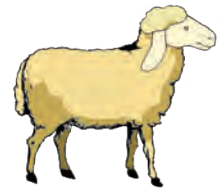

sheep



van



volleyball

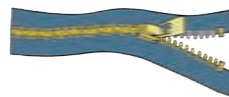

zipper

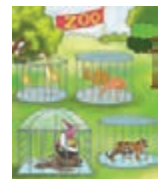

ZOO

Sentences



Hello.



I'm Ali.



I'm Saman Ahmadi, and you?



Goodbye.



It's a bag.



It's an apple.

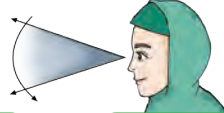

Look.



Listen.



Read.



Write.



Repeat.



Come in, please.



Go out, please.



Sit down, please.



Stand up, please.



Open the book.



Clean the board.



Close the book.

List of Instructions

Ask the students to find and say the familiar English words.	از دانش‌آموزان بخواهید که لغات آشنای انگلیسی را پیدا کنند و بگویند.
Ask the students to introduce themselves to each other using the pattern.	از دانش‌آموزان بخواهید مطابق الگو خود را به یکدیگر معرفی کنند.
Ask the students to say “hello” to each other.	از دانش‌آموزان بخواهید به یکدیگر سلام کنند.
Ask the students to say “hello” and introduce themselves to each other.	از دانش‌آموزان بخواهید به یکدیگر سلام کنند و خود را معرفی کنند.
Ask the students to say “goodbye” to each other.	از دانش‌آموزان بخواهید از هم خداحافظی کنند.
Ask your friend to act out the commands.	از دوستان بخواهید دستورها را انجام دهد.
Check your learning.	مشخص کنید چه چیزی را یاد گرفته‌اید.
Circle the correct number.	دور عدد درست دایره بکشید.
Complete your ID card.	کارت شناسایی خود را کامل کنید.
Count and circle the correct number.	بشمارید و دور شماره درست دایره بکشید.
Count and trace.	بشمارید و ردیابی کنید.
Count and write the numbers.	بشمارید و اعداد را بنویسید.
Fill the form.	فرم را پر کنید.
Find and circle the letters “a” and “t”.	حروف "a" و "t" را پیدا کنید و دور آنها خط بکشید.
Find and circle the letters “d” and “j”.	حروف "d" و "j" را پیدا کنید و دور آنها خط بکشید.

Find and circle the letters “h” and “b”.	حروف "h" و "b" را پیدا کنید و دور آنها خط بکشید.
Find and circle the letters “v” and “z”.	حروف "v" و "z" را پیدا کنید و دور آنها خط بکشید.
Listen.	گوش کنید.
Listen again and point to the pictures above.	دوباره گوش کنید و به تصاویر بالا اشاره کنید.
Listen and act out.	گوش کنید و انجام دهید.
Listen and answer.	گوش کنید و پاسخ دهید.
Listen and chant.	گوش کنید و آواز بخوانید.
Listen and check the correct numbers.	گوش کنید و اعداد صحیح را علامت بزنید.
Listen and check the correct item.	گوش کنید و مورد درست را علامت بزنید.
Listen and check the correct picture.	گوش کنید و تصویر درست را علامت بزنید.
Listen and choose the correct picture.	گوش کنید و تصویر درست را انتخاب کنید.
Listen and circle.	گوش کنید و دایره بکشید.
Listen and circle the letters.	گوش کنید و دور حروف دایره بکشید.
Listen and circle the initial letters.	گوش کنید و دور حروف ابتدایی دایره بکشید.
Listen and circle the letters in each word.	گوش کنید و دور حروف در هر لغت دایره بکشید.
Listen and color the pictures.	گوش کنید و تصاویر را رنگ کنید.
Listen and point.	گوش کنید و اشاره کنید.

Listen and repeat.	گوش کنید و تکرار کنید.
Listen and trace.	گوش کنید و ردیابی کنید.
Listen and write.	گوش کنید و بنویسید.
Listen and write the correct numbers.	گوش کنید و اعداد صحیح را بنویسید.
Listen and write the missing letters.	گوش کنید و حروف جامانده را بنویسید.
Listen and write the missing numbers.	گوش کنید و اعداد جامانده را بنویسید.
Listen to the commands above and act out what you hear.	به دستورهای بالا گوش کنید و آنچه را می شنوید انجام دهید.
Listen to the commands above and do what you hear.	به دستورهای بالا گوش کنید و آنچه را می شنوید انجام دهید.
Listen to the following ID numbers and repeat.	به شماره کارت‌های شناسایی زیر گوش کنید و آنها را تکرار کنید.
Listen to the phone numbers and repeat.	به شماره‌های تلفن گوش کنید و تکرار کنید.
Listen, write, and say the phone numbers.	گوش کنید، بنویسید و شماره تلفن‌ها را بگویید.
Look at the pictures and write the initial letters.	به تصاویر نگاه کنید و حروف ابتدایی آنها را بنویسید.
Look and circle the initial letters.	نگاه کنید و دور حروف ابتدایی دایره بکشید.
Look and write the missing letters.	نگاه کنید و حروف حذف شده را بنویسید.
Look, listen and repeat.	نگاه کنید، گوش کنید و تکرار کنید.
Match the pictures with the initial letters.	تصاویر را به حروف ابتدایی‌شان وصل کنید.

Match the small letters with the capital letters.	حروف کوچک را به حروف بزرگ وصل کنید.
Point and name the colors.	به رنگ ها اشاره کنید و آنها را نام ببرید.
Point to each number and ask your friend to say it.	به هر شماره اشاره کنید و از دوستتان بخواهید آن را بگوید.
Point to each number and ask your friend to read it.	به هر شماره اشاره کنید و از دوستتان بخواهید آن را بخواند.
Point to each picture and ask your friend to name it.	به هر تصویر اشاره کنید و از دوستتان بخواهید آن را نام ببرد.
Put the following numbers in the correct order.	اعداد زیر را به ترتیب بنویسید.
Read aloud.	بلند بخوانید.
Say your phone number and ask your friend to write it down.	شماره تلفن خود را بگویید و از دوستتان بخواهید آن را بنویسد.
Tell your friend your ID number.	به دوستتان شماره کارت شناسایی خود را بگویید.
Tell your friend your phone number.	به دوستتان شماره تلفن خود را بگویید.
Tell your friend your school telephone number.	به دوستتان شماره تلفن مدرسه را بگویید.
Trace from left to right.	از چپ به راست ردیابی کنید.
Trace and practice the patterns.	الگوها را ردیابی و تمرین کنید.
Trace and write the letters.	ردیابی کنید و حروف را بنویسید.
Trace and write the numbers.	ردیابی کنید و اعداد را بنویسید.
Write the missing numbers.	جای خالی اعداد را پر کنید.

Worksheet for Letters

C

c

O

o

A

a

T

t

H

h

I

i

U

u

B

b

E

e

N

n

D

d

J

j

M

m

P

p

V

v

Z

z

Audio Scripts

Starter

1. Mina Sina

Lesson 1: Greetings

1. Hello. Hello.

2. Mr. Ahmadi Reza Ali

3. Hello, I'm Reza. Hello, I'm Ali.

4.

1. Hello, I'm Mina.

2. Hello, I'm Ali.

5.

1. Hello, I'm Sina.

2. Hello, I'm Reza.

3. Hello, I'm Ali.

4. Hello, I'm Ahmadi.

6. Hello. I'm Saman Ahmadi, and you?

7.

1. I'm Ali, and you? I'm Reza.

2. I'm Sina, and you? I'm Ali.

3. I'm Sina, and you? I'm Reza.

8. I'm Ahmadi, and you?

I'm Reza.

I'm Ali.

9.

C c [k]

O o [ɑ] [ʌ]

10.

[k] cat

[ɑ] orange

[k] candy

[ʌ] oven

11.

[k] cat

[ɑ] orange

[k] candy

[ʌ] oven

12.

It's an oven; "o", "o", oven.

It's an orange; "o", "o", orange.

It's a cat; "c", "c", cat.

It's a candy; "c", "c", candy.

13.

1. Orange 2. Oven 3. Cat 4. Candy

14.

1. Orange 2. Candy 3. Oven 4. Cat

15. Cat Orange

16. [k] [ʌ], [ɑ]

17. 1. Oven 2. Cat

3. Orange 4. Candy

18.

1. Candy 2. Orange

3. Cat 4. Oven

19. one two

20. A: 1 B: 2

21. Goodbye. Goodbye.

Lesson 2: My Classroom

1. It's a desk.

2.

It's a desk.

It's a bag.

It's a pen.

It's a book.

- 3.
- | | |
|---------|---------|
| 1. Bag | 2. Pen |
| 3. Desk | 4. Book |

- 4.
- | | |
|---------|---------|
| 1. Bag | 2. Pen |
| 3. Desk | 4. Book |

- 5.
- | | |
|-----|-----|
| A a | [æ] |
| T t | [t] |

- 6.
- | | |
|-----|-------|
| [æ] | apple |
| [t] | tiger |
| [æ] | ant |
| [t] | tea |

- 7.
- | | |
|-----|-------|
| [æ] | apple |
| [t] | tiger |
| [æ] | ant |
| [t] | tea |

- 8.
- It's an apple; "a", "a", apple.
- It's an ant; "a", "a", ant.
- It's a tiger; "t", "t", tiger.
- It's tea; "t", "t", tea.

- 9.
- | | |
|--------|----------|
| 1. Ant | 2. Apple |
| 3. Tea | 4. Tiger |

- 10.
- | | |
|----------|--------|
| 1. Tiger | 2. Ant |
| 3. Apple | 4. Tea |

- 11.
- | | |
|-------|-------|
| Tiger | Apple |
|-------|-------|

12. a t

- 13.
- | | |
|----------|----------|
| 1. Ant | 2. Tiger |
| 3. Apple | 4. Tea |

- 14.
- | | |
|----------|----------|
| 1. Tiger | 2. Apple |
| 3. Tea | 4. Ant |

15. 3 4

16. A: 1 2
B: 3 4

Review 1

- 1.
- | | |
|-------------|---------|
| 1. Goodbye. | 2. Ant |
| 3. Apple | 4. Desk |
- 2.
- | | |
|----------|----------|
| 1. Tiger | 2. Candy |
|----------|----------|
- 3.
- | | | | |
|------|------|------|------|
| 1. a | 2. c | 3. o | 4. t |
|------|------|------|------|
- 4.
- | | | | |
|-----------|--------|----------|----------|
| 1. Orange | 2. Bag | 3. Tiger | 4. Apple |
|-----------|--------|----------|----------|

Lesson 3: Classroom Commands 1

- 1.
- | | | |
|--------|--------|-------|
| Read | Repeat | Write |
| Listen | Look | |
- 2.
- | | | |
|-------|--------|------|
| Look | Listen | Read |
| Write | Repeat | |

3.

Look	Listen	Read
Write	Repeat	

4.

1. Listen	2. Repeat	3. Look
4. Read		

5.

1. Look	2. Write	3. Repeat
4. Read	5. Listen	

6.

Ii	[i]
Hh	[h]

7.

[i]	ink
[h]	hat
[i]	ill
[h]	horse

8.

[i]	ink
[h]	hat
[i]	ill
[h]	horse

9.

It's ink; "i", "i", ink.
 He's ill; "i", "i", ill.
 It's a hat; "h", "h", hat.
 It's a horse; "h", "h", horse.

10.

1. Ill	2. Horse
3. Hat	4. Ink

11.

1. Horse	2. Ink
3. Ill	4. Hat

12.

Ink	Horse
-----	-------

13.

i	h
---	---

14.

1. Horse	2. Ill
3. Hat	4. Ink

15.

1. Ink	2. Hat
3. Ill	4. Horse

16.

5	6
---	---

17.

A: 1	2	3
B: 4	5	6

Lesson 4: Colors

1.

Red	Blue
Green	Yellow

2.

Red	Blue
Green	Yellow

3.

1. Blue	2. Green
3. Red	4. Yellow

4.

1. Yellow	2. Red
3. Blue	4. Green

5.

The apple is red.

The pen is blue.

The hat is yellow.

The bag is green.

6.

Uu [ʌ]

Bb [b]

7.

[ʌ] umbrella

[b] ball

[ʌ] up

[b] bed

8.

[ʌ] umbrella

[b] ball

[ʌ] up

[b] bed

9.

Up, “u”, “u”, up.

It’s an umbrella; “u”, “u”, umbrella.

It’s a ball; “b”, “b”, ball.

It’s a bed; “b”, “b”, bed.

10.

1. Up 2. Umbrella

3. Bed 4. Ball

11.

1. Ball 2. Up

3. Bed 4. Umbrella

12.

ball up

13.

b u

14.

1. Umbrella 2. Ball

3. Up 4. Bed

15.

1. Umbrella 2. Bed

3. Up 4. Ball

16.

7 8 9

17.

A: 1 2 3

B: 4 5 6

C: 7 8 9

Review 2

1.

1. Write 2. Listen

3. Repeat 4. Look

2.

The bag is red.

The hat is yellow.

The ball is green.

The umbrella is blue.

3.

1. u 2. i

3. h 4. b

4.

1. Bed 2. Up

3. Hat 4. Ill

Lesson 5: Classroom Commands 2

1.

Come in.	Sit down.
Stand up.	Go out.
2.

Come in, please.	Go out, please.
Sit down, please.	Stand up, please.
3.

Come in, please.	Go out, please.
Sit down, please.	Stand up, please.
4.

1. Go out.	2. Stand up.
3. Come in.	4. Sit down.
5.

1. Go out.	2. Come in.
3. Stand up.	4. Sit down.
6.

1. Sit down.	2. Come in.
3. Go out.	4. Stand up.
7.

Ee	[e]
Nn	[n]
8.

[e]	egg
[n]	nose
[e]	exit
[n]	night
9.

[e]	egg
[n]	nose
[e]	exit
[n]	night

10.

It's an egg; "e", "e", egg.

It's an exit; "e", "e", exit.

It's a nose; "n", "n", nose.

It's night; "n", "n", night.

11.

- | | |
|----------|---------|
| 1. Nose | 2. Egg |
| 3. Night | 4. Exit |

12.

- | | |
|---------|----------|
| 1. Egg | 2. Night |
| 3. Exit | 4. Nose |

13.

Night	Egg
-------	-----

14.

e	n
---	---

15.

- | | |
|---------|----------|
| 1. Egg | 2. Nose |
| 3. Exit | 4. Night |

16.

- | | |
|---------|----------|
| 1. Egg | 2. Night |
| 3. Exit | 4. Nose |

17.

0	10
---	----

18.

- | | | | |
|----|----|---|---|
| A: | 10 | 2 | 3 |
| B: | 5 | 6 | 9 |
| C: | 1 | 5 | 7 |
| D: | 8 | 4 | 0 |

Lesson 6: Fruits

1.

- | | |
|-------|--------|
| apple | banana |
| pear | fig |

2.

- 1. It's an apple.
- 2. It's a banana.
- 3. It's a pear.
- 4. It's a fig.

3.

- 1. Pear 2. Banana 3. Apple 4. Fig

4.

- 1. Fig 2. Pear 3. Banana 4. Apple

5.

- Dd [d]
- Jj [dʒ]

6.

- [d] door
- [dʒ] jam
- [d] doctor
- [dʒ] jungle

7.

- [d] door
- [dʒ] jam
- [d] doctor
- [dʒ] jungle

8.

- It's a door; "d", "d", door.
- He's a doctor; "d", "d", doctor.
- It's jam; "j", "j", jam.
- It's a jungle; "j", "j", jungle.

9.

- 1. Door 2. Jungle
- 3. Doctor 4. Jam

10.

- 1. Jam 2. Doctor
- 3. Jungle 4. Door

11.

- Jam door

12.

- d j

13.

- 1. Door 2. Jam
- 3. Doctor 4. Jungle

14.

- 1. doctor 2. Jungle
- 3. Door 4. jam

15.

- | | | | | | |
|---|---|---|---|----|---|
| 0 | 1 | 2 | 3 | 4 | 5 |
| 6 | 7 | 8 | 9 | 10 | |

16.

- | | | | | |
|-----|-----|-----|-----|-----|
| 125 | 110 | 115 | 118 | 123 |
|-----|-----|-----|-----|-----|

17.

- | | | | |
|-----|-----|-----|-----|
| 125 | 115 | 110 | 118 |
|-----|-----|-----|-----|

18.

- A. 110 B. 115

19.

- | | |
|-----|-----|
| 123 | 118 |
|-----|-----|

20.

- | | | | | |
|-----|-----|-----|-----|-----|
| 123 | 110 | 115 | 118 | 125 |
|-----|-----|-----|-----|-----|

Review 3

1.

- 1. Stand up. 2. Come in.
- 3. Apple 4. Egg

2.

- 1. Doctor 2. Night

3.

- 1. n 2. e 3. d

4.

- 1. Exit 2. Jungle
- 3. Night 4. Doctor

5.

- A. 123 B. 125

6.

- 125 123 110 118 115

Lesson 7: Classroom Commands 3

1.

- Close the book.
- Open the book.
- Clean the board.

2.

- Close the book.
- Open the book.
- Clean the board.

3.

- Close the book.
- Open the book.
- Clean the board.

4.

- 1. Open the book.
- 2. Close the book.
- 3. Clean the board.

5.

- 1. Close the book.
- 2. Open the book.
- 3. Clean the board.

6.

- 1. Close the book.
- 2. Open the book.
- 3. Clean the board.

7.

- Mm [m]
- Pp [p]

8.

- [m] money
- [p] park
- [m] map
- [p] printer

9.

- [m] money
- [p] park
- [m] map
- [p] printer

10.

- It's a map; "m", "m", map.
- It's money; "m", "m", money.
- It's a printer; "p", "p", printer.
- It's a park; "p", "p", park.

11.

- 1. Printer 2. Money
- 3. Map 4. Park

12.

- 1. Park 2. Money
- 3. Printer 4. Map

13.

- Printer Money

14.

m p

15.

- 1. Money 2. Park
- 3. Map 4. Printer

16.

- 1. Map 2. Printer
- 3. Money 4. Park

17. 88309261

02166971695

00982166971599

18.

A. 08627011421

B. 08712350042

Lesson 8: Animals

1.

cat dog hen sheep

2.

It's a cat.

It's a dog.

It's a hen.

It's a sheep.

3.

- 1. Cat 2. Hen
- 3. Dog 4. Sheep

4.

- 1. Dog 2. Hen
- 3. Cat 4. Sheep

5.

Vv [v]

Zz [z]

6.

[v] van

[z] zipper

[v] volleyball

[z] zoo

7.

[v] van

[z] zipper

[v] volleyball

[z] zoo

8.

“V”, “v”, volleyball.

It's a van; “v”, “v”, van.

It's a zipper; “z”, “z”, zipper.

It's a zoo; “z”, “z”, zoo.

9.

1. Van 2. Zoo

3. Zipper 4. Volleyball

10.

1. Van 2. Zipper

3. Volleyball 4. Zoo

11.

zoo volleyball

12.

v z

13.

1. Van 2. Zipper

3. Volleyball 4. Zoo

14.

- | | |
|---------------|-----------|
| 1. Van | 2. Zipper |
| 3. Volleyball | 4. Zoo |

15.

ID CARD

ID No: 0040210250

First Name: Sina

Last Name; Hasani

16.

0030102509

0041250683

Review 4

1.

1. Close the book.
2. Clean the board.
3. Dog
4. Hen

2.

1. Zoo
2. Sheep

3.

1. V
2. P
3. M

4.

- | | |
|-----------|------------|
| 1. Zipper | 2. Printer |
| 3. Money | 4. Van |

